

# PULSACOIL 2000

## DESIGN, INSTALLATION AND SERVICING INSTRUCTIONS

### Gas Council Approved Reference Numbers

PulsaCoil 145 97-317-32  
PulsaCoil 185 97-317-33  
PulsaCoil 215 97-317-34  
PulsaCoil 235 97-317-35



*The code of practice for the installation,  
commissioning & servicing of central heating systems*

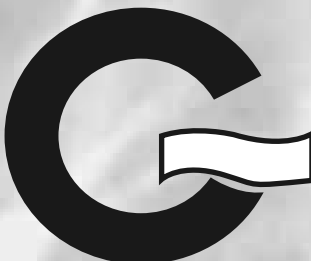

**A MAINS PRESSURE HOT WATER SUPPLY  
SYSTEM INCORPORATING AN OFF PEAK  
ELECTRIC THERMAL STORE**

**ALL MODELS COMPLY WITH THE  
WATER HEATER MANUFACTURERS  
SPECIFICATION FOR THERMAL STORES**

# CONTENTS

## ISSUE 11: 06-08

Section	Page
<b>1.0 DESIGN</b>	
1.1 Introduction	3
1.2 Technical Data	5
1.3 System Details	9
<b>2.0 INSTALLATION</b>	
2.1 Site Requirements	13
2.2 Installation	14
2.3 Commissioning	18
<b>3.0 SERVICING</b>	
3.1 Annual Servicing	20
3.2 Changing Components	20
3.3 Short Parts List	21
3.4 Fault Finding	22
Appendix A	24
Appendix B	25
Appendix C	28
Appendix D	29
Terms & Conditions	30



*The code of practice for the installation,  
commissioning & servicing of central heating systems*

As part of the industry wide "Benchmark" Initiative all Gledhill PulsaCoils now include a Benchmark Installation, Commissioning and Service Record Log Book. Please read carefully and complete all sections relevant to the appliance installation. The details of the Log Book will be required in the event of any warranty work being required. There is also a section to be completed after each regular service visit. **The completed Log Book and these instructions should be left in the pocket provided on the back of the front panel.**

The Gledhill PulsaCoil range is a WBS listed product and complies with the WMA Specification for hot water only thermal storage products. The principle was developed originally in conjunction with British Gas. This product is manufactured under an ISO 9001:2000 Quality System audited by BSI.

**The Gledhill Group's first priority is to give a high quality service to our customers.**

**Quality is built into every Gledhill product and we hope you get satisfactory service from Gledhill.**

**If not please let us know.**

# 1.0 DESIGN

## 1.1 INTRODUCTION

Any water distribution system/installation must comply with the relevant recommendations of the current version of the Regulations and British Standards listed below:-

Building Regulations  
Requirements for Electrical Installations  
Water Regulations  
Manual Handling Operations Regulations

**British Standards**  
BS6700 and BS7671.

A competent person must install the PulsaCoil domestic hot water system. The manufacturer's notes must not be taken as overriding statutory obligations.

The PulsaCoil 2000 is not covered by section G3 of the current Building Regulations and is therefore not notifiable to Building Control.

The information in this manual is provided to assist generally in the selection of equipment. The responsibility for the selection and specification of the equipment must however remain that of the customer and any Designers or Consultants concerned with the design and installation.

**Please Note:** We do not therefore accept any responsibility for matters of design, selection or specification or for the effectiveness of an installation containing one of our products unless we have been specifically requested to do so.

All goods are sold subject to our Conditions of Sale, which are set out at the rear of this manual.

In the interest of continuously improving the PulsaCoil range, Gledhill Water Storage Ltd reserve the right to modify the product without notice, and in these circumstances this document, which is accurate at the time of printing, should be disregarded. It will however be updated as soon as possible after the change has occurred.



# 1.0 DESIGN

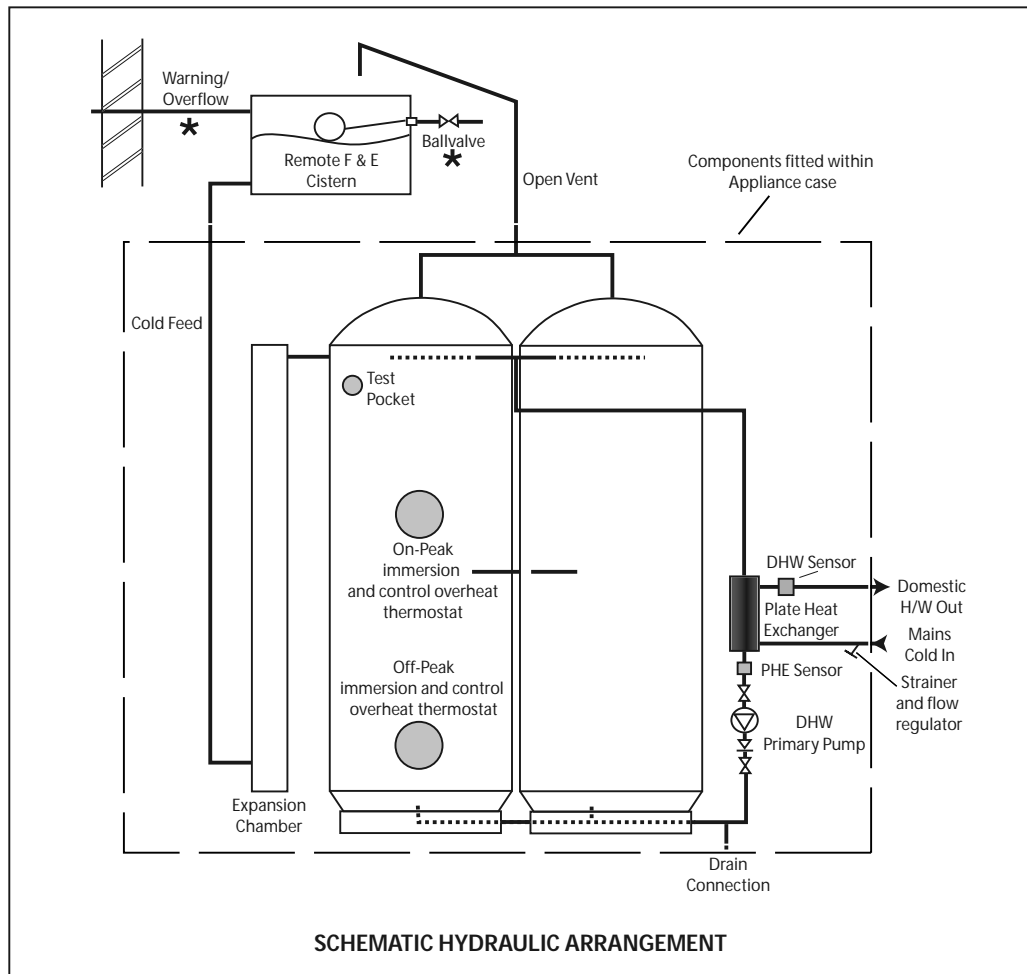

## 1.1 INTRODUCTION

### Description

The Pulsacoil 2000 shown schematically above is designed to provide an improved method of supplying mains pressure hot water when used with a suitable off peak electric supply/tariff.

Because of the efficiency of the appliance improved SAP ratings can be achieved. Further details are available from the Gledhill Technical Department.

An important feature of the concept is that hot water can be supplied directly from the mains at conventional flow rates without the need for temperature and pressure relief safety valves or expansion vessels. This is achieved by passing the mains water through a plate heat exchanger. The outlet temperature of the domestic hot water is maintained by the Pump Speed Control (P.S.C.) board, which controls the speed of the pump circulating the primary water from the store through the plate heat exchanger.

To comply with the Benchmark Guidance Note for Water Treatment in heating and hot water systems the installer should check the hardness levels of the water supply and if necessary fit an in-line scale inhibitor/reducer to provide protection to the whole of the domestic water system.

If scale should ever become a problem the plate heat exchanger is easily isolated and quickly replaced with a service exchange unit which can be obtained at a nominal cost from Gledhill. For further details see Hot and Cold Water Systems, page 9.

The PSC incorporates the facility to automatically run the D.H.W. primary pump for about 3 seconds every 30 hours to help prevent it sticking. For this reason we would recommend that once the appliance is installed it should be commissioned and the electricity left on to the appliance.

**\* Note: The standard appliance is supplied as a manual fill model i.e. without a ballvalve and overflow which makes it particularly suitable for use in flats/apartments. A ballvalve and overflow fitting can be supplied as an optional extra if required.**

# 1.0 DESIGN

## 1.2 TECHNICAL DATA

New Model Range		PC145	PC185	PC215	PC235
Appliance Weight					
-Empty-	(Kg)	62	68	71	74
-Full-	(Kg)	202	238	261	294
Volume of water heated (on-peak heater)	(litres)	65	65	70	75
MCW & DHW Pipe connections	(mm)	22	22	22	22
Cold feed/expansion connection	(mm)	15	15	15	15
Safety open vent connection	(mm)	22	22	22	22
Drain connection		R 1/2"	R 1/2"	R 1/2"	R 1/2"
Maximum head	(m)	10	10	10	10
Hot water flow rate	(lts/min)	up to 35	up to 35	up to 35	up to 35

MODEL SELECTION GUIDE				
Dwelling Type				
Bedroom	1-2	2-3	2-3	2-4
Bathrooms	1	1	1	2
En-Suite shower rooms	or 1	1	2	1
Standard Economy 7 tariff	PC145	PC185	PC215	PC235
Economy 10 or Heatwise tariff	PC145	PC145	PC145	PC185

### Notes:-

1. Plastic feed and expansion cistern will be supplied separately.
2. The flow rates are based on a 35°C temperature rise and assume normal pressure and adequate flow to the appliance. The actual flow rate from the appliance is automatically regulated to a maximum of 28 litres/min.
3. Unit is supplied on a 100mm high installation base.
4. The domestic hot water outlet temperature is automatically regulated to approximately 55°C at the bath flow rate of 18 litres/min recommended by BS 6700. The temperature is not user adjustable.

# 1.0 DESIGN

## 1.2 TECHNICAL DATA

### Standard Equipment

The standard configuration of the PulsaCoil 2000 is shown opposite. The Pump Speed Control Board (P.S.C.), mounted inside the appliance, controls the operation of the complete system. The P.S.C. is pre-wired to a terminal strip where all electrical connections terminate. It is supplied with the following factory fitted equipment:-

1. 3kW off-peak immersion heater with control and overheat rod thermostat
2. 3kW on-peak boost immersion heater with control and overheat rod thermostat
3. Pump Speed Control Board (P.S.C.)
4. Plate heat exchanger
5. Domestic hot water primary (plate heat exchanger) pump
6. Isolating terminal connectors for dry fire protection
7. DHW temperature sensor
8. PHE return sensor
9. Strainer and flow regulator
10. Screwed connection for a drain tap
11. A feed and expansion cistern complete with cold feed/open vent pipework assembly is supplied separately.

**Note :** Both immersion heaters are low watts density type with incaloy 825 sheaths and are specially manufactured to suit Thermal Stores. It is recommended that any replacements should be obtained from Gledhill Water Storage.

### Optional Extra Equipment

- Flexible connectors for quick connection to first fix pipe installation. For further details see 2.2 Installation, Pipework connections.
- Hot and cold water manifolds for use with plastic pipework.
- Ballvalve/overflow connector for F & E cistern

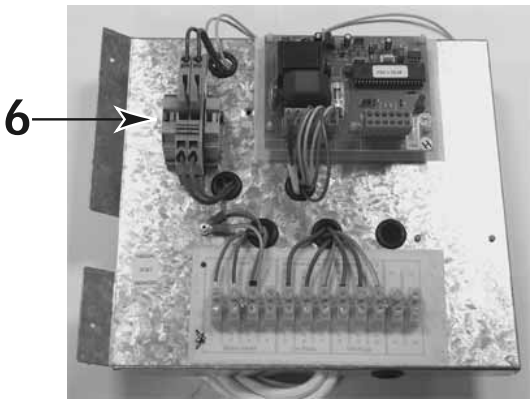
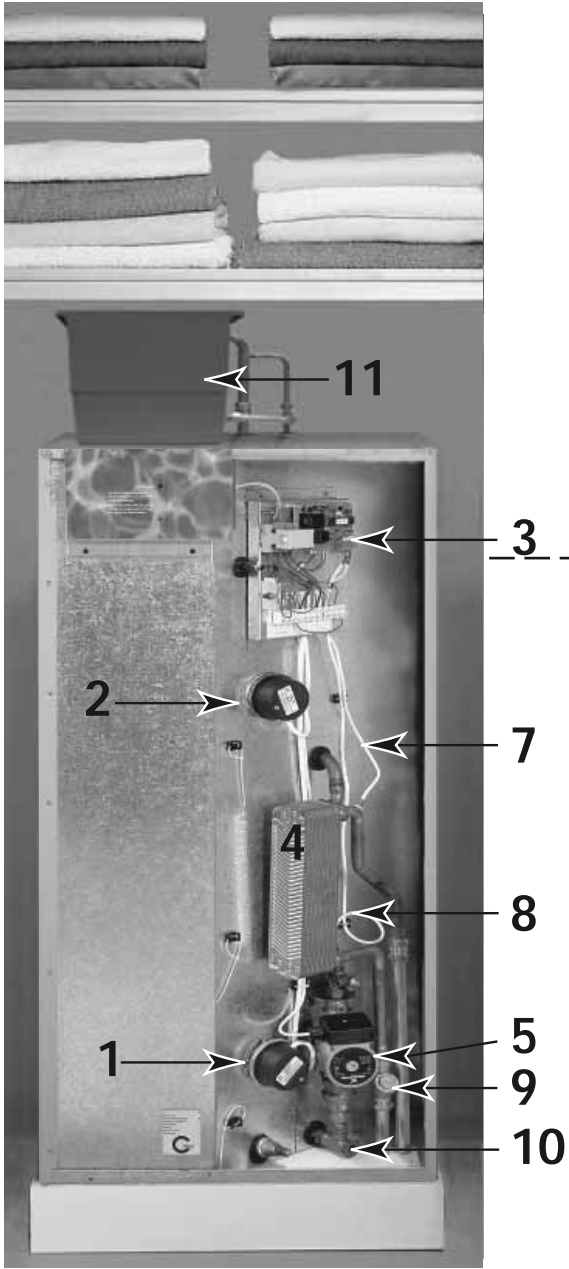

Pump Speed Control Board  
P.S.C

# 1.0 DESIGN

## 1.2 TECHNICAL DATA

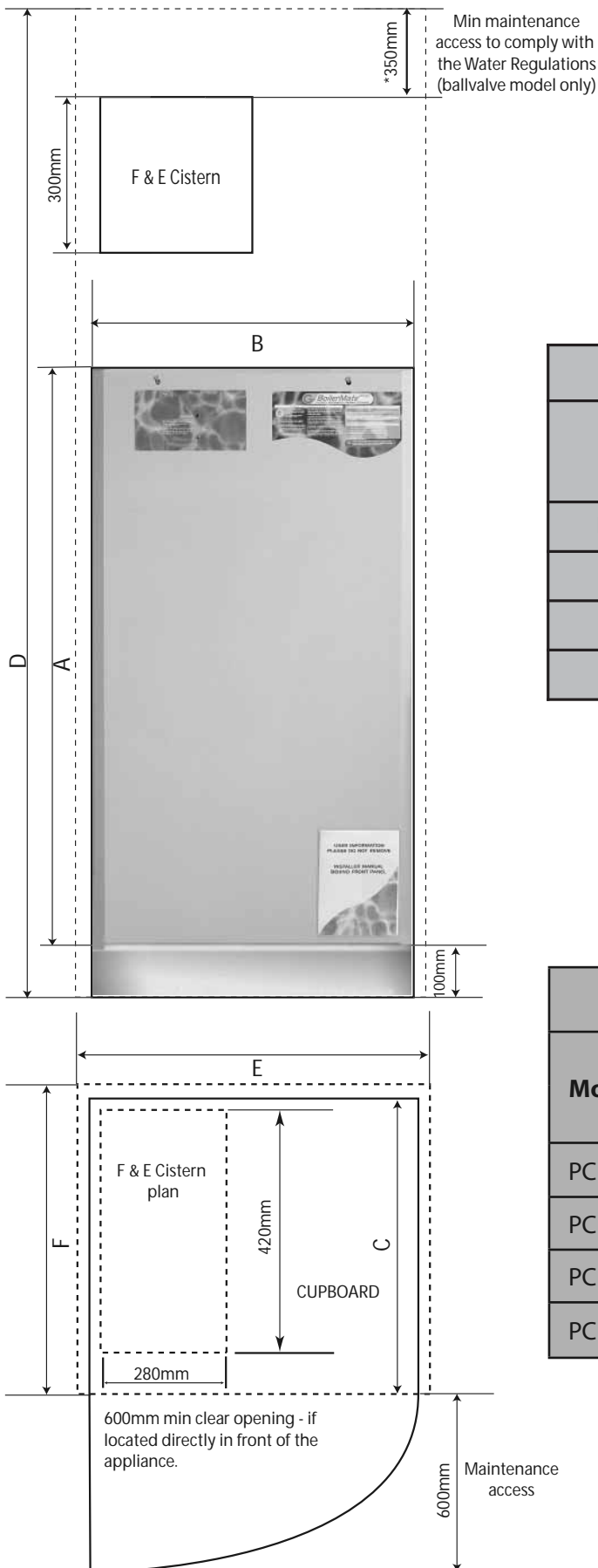

APPLIANCE DIMENSIONS			
Model	Height	Width	Depth
	A	B	C
PC 145	1140mm	595mm	575mm
PC 185	1360mm	595mm	575mm
PC 215	1500mm	595mm	575mm
PC 235	1700mm	595mm	575mm

**Note:** The Appliance dimensions above do not allow for the 100mm high installation base

The following table of minimum cupboard dimensions only allow the minimum space required for the appliance (including the F & E cistern). Any extra space required for shelving etc in the case of airing cupboards etc must be added.

MINIMUM CUPBOARD DIMENSIONS			
Model	Height	Width	Depth
	D	E	F
PC 145	1890mm	700mm	600mm
PC 185	2110mm	700mm	600mm
PC 215	2250mm	700mm	600mm
PC 235	2450mm	700mm	600mm

**Note:** The above dimensions are based on the Appliance and the F & E cistern (fitted with a ballvalve) being in the same cupboard. If the manual fill method is chosen the heights can be reduced by 125mm.

# 1.0 DESIGN

## 1.2 TECHNICAL DATA

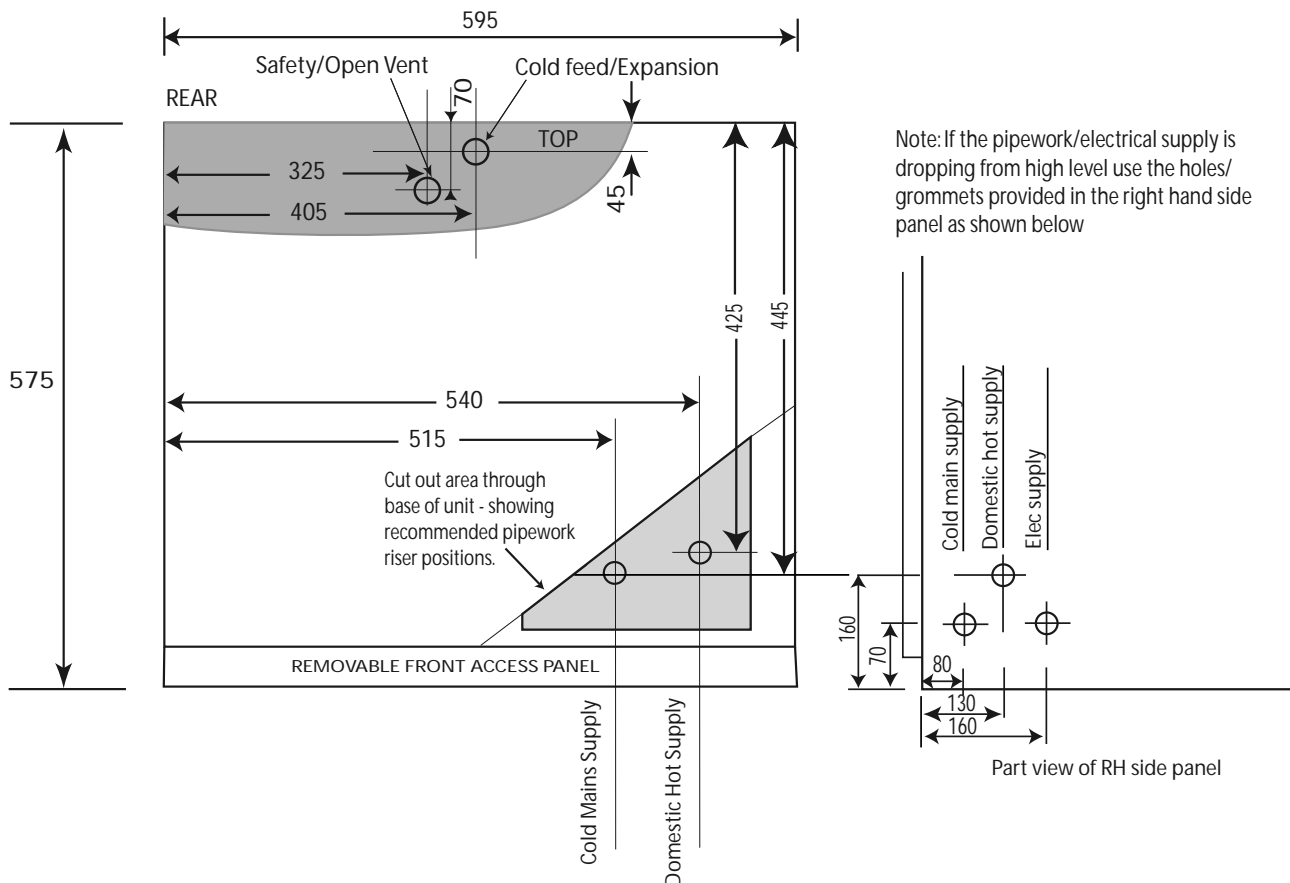

### PLAN OF APPLIANCE CONNECTIONS

The Pulsacoil 2000 units are supplied on an installation base to allow the pipe runs to connect to the appliance from any direction. It is easier if all pipes protrude vertically in the cut out area shown. Compression or push fit connections can be used and we do offer a set of flexible connectors as an option. All pipe positions are approximate and subject to a tolerance of +/- 10mm in any direction. Space will also be required for a 15mm cold water supply and a 22mm warning / overflow pipe (if provided) for the separate feed and expansion cistern.

If a warning/overflow pipe is NOT provided the F&E Cistern should be filled from a temporary hose connection incorporating a double check valve. This can be from a temporary hose connection supplied from a cold water tap or a permanent cold branch provided adjacent to the F&E Cistern. The temporary connection must be removed once the appliance is filled.



## 1.3 SYSTEM DETAILS

### Hot and Cold Water System

#### General

A schematic layout of the hot and cold water services in a typical small dwelling is shown below. Pulsacoil 2000 will operate at mains pressures as low as 1 bar and as high as 5 bar although the recommended range is 2-3 bar dynamic at the appliance. If the manifolds (available as an optional extra) are being used the inlet pressure to the manifold must be a minimum of 2 bar. It is also important to check that all other equipment and components in the hot and cold water system are capable of accepting the mains pressure available to the property. If the mains pressure can rise above 5 bar or the maximum working pressure of any item of equipment or component to be fitted in the system, a pressure limiting (reducing) valve set to 3 bar will be required.

If you encounter a situation where the water pressure is adequate but flow rates are poor please contact our technical helpline for details of an effective solution.

**Note :** Each Pulsacoil 2000 is fitted with a strainer and flow regulator on the cold mains supply connection. If the supply pressure is less than 2 bar or if the manifolds (available as an optional extra) are being used or if all taps are provided with flow regulators the flow regulator on the cold inlet should be removed.

No check valve or similar device should be fitted on the cold water supply branch to the Pulsacoil 2000.

To comply with the Benchmark Guidance Note for Water Treatment in Heating and Hot Water Systems the installer should check the hardness level of the water supply and if necessary fit an in-line scale inhibitor/reducer to provide protection to the whole of the domestic water system. See Appendix C for a copy of the relevant part of the Benchmark Guidance Note.

When specifying this appliance we would recommend that for hardness levels above 200ppm (mg/l) a hard water appliance is used. For hardness levels above 250ppm (mg/l) we would recommend that some form of in-line scale inhibitor/reducer recommended by one of the water treatment companies listed in the Benchmark Guidance Note is also fitted

The hot water flow rate from the Pulsacoil 2000 is directly related to the adequacy of the cold water supply to the dwelling. This must be capable of providing for those services, which could be required to be supplied simultaneously, and this maximum demand should be calculated using procedures defined in BS 6700.

If a water meter is fitted in the service pipe, it should have a nominal rating to match the maximum hot and cold water peak demands calculated in accordance with BS 6700. This could be up to 60ltr/min in some properties.

**Note:** The diagram below shows the F & E cistern with ballvalve and warning/overflow pipe which can be fitted if required. However, the standard preferred arrangement is for the cistern to be manually filled from a temporary hose connection fitted with a double check valve.

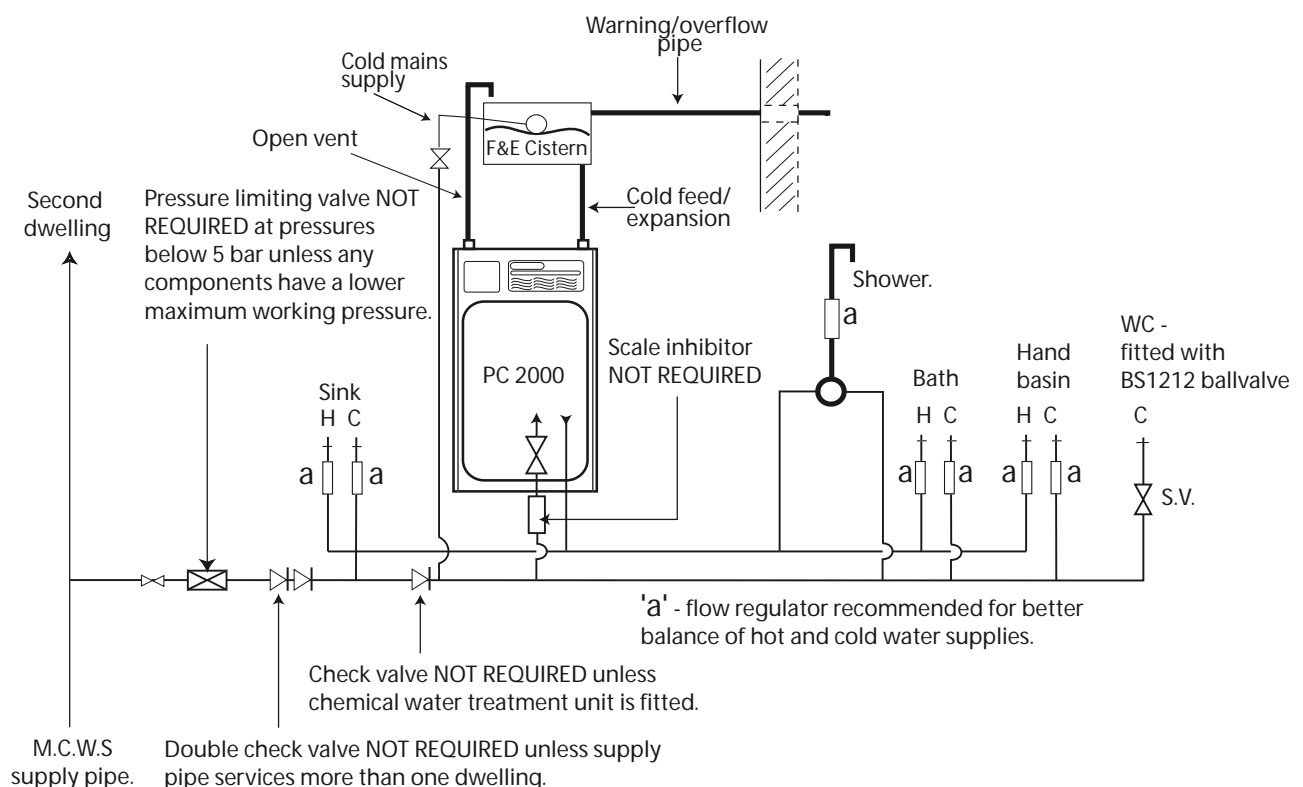

Typical hot and cold water distribution

## 1.3 SYSTEM DETAILS

### Hot and Cold Water System

#### Pipe Sizing / Materials

To achieve even distribution of the available supply of hot and cold water, it is important in any mains pressure system, that the piping in a dwelling should be sized in accordance with BS 6700. This is particularly important in a large property with more than one bathroom.

However, the following rule of thumb guide lines should be adequate for most smaller property types as long as water pressures are within the recommended range.

1. A 15mm copper or equivalent external service may be sufficient for a small 1bathroom dwelling (depending upon the flow rate available), but the minimum recommended size for new dwellings is 22mm (25mm MDPE).
2. The internal cold feed from the main incoming stop tap to the PulsaCoil should be run in 22mm pipe. The cold main and hot draw-off should also be run in 22mm as far as the branch to the bath tap.
3. The final branches to the hand basins and sinks should be in 10mm and to the baths and showers in 15mm. (1 metre minimum)
4. **We would recommend that best results for a balanced system are achieved by fitting appropriate flow regulators to each hot and cold outlet. This is particularly relevant where the water pressures are above the recommended water pressure range. Details of suitable flow regulators are provided in Appendix A.**

**Note: If manifolds (available as an optional extra) are being used suitable flow regulators are automatically provided in the manifold and do not need to be provided at each outlet. See Appendix B for further details.**

All the recommendations with regard to pipework systems in this manual are generally based on the use of BS/EN Standard copper pipework and fittings.

However, we are happy that plastic pipework systems can be used in place of copper internally as long as the chosen system is recommended for use on domestic hot and cold water systems by the manufacturer and is installed fully in accordance with their recommendations.

This is particularly important in relation to use of push fit connections when using the optional flexible hose kits - see 2.2 Installation, Pipework connections.

It is also essential that if an alternative pipework material/system is chosen the manufacturer confirms that the design criteria of the new system is at least equivalent to the use of BS/EN Standard copper pipework and fittings.

#### Taps/Shower Fittings

Aerated taps are recommended to prevent splashing.

**Any type of shower mixing valve can be used as long as both the hot and cold supplies are mains fed. However all mains pressure systems are subject to dynamic changes particularly when other hot and cold taps/showers are opened and closed, which will cause changes in the water temperature at mixed water outlets such as showers. For this reason and because these are now no more expensive than a manual shower we strongly recommend the use of thermostatic showers with this appliance.**

**The shower head provided must also be suitable for mains pressure supplies.**

However, if it is proposed to use a 'whole body' or similar shower with a number of high flow/pressure outlets please discuss with the Gledhill technical department.

The hot water supply to a shower-mixing valve should be fed wherever practical directly from the PulsaCoil 2000 or be the first draw-off point on the hot circuit. The cold supply to a shower-mixing valve should wherever practical be fed directly from the rising mains via an independent branch. The shower must incorporate or be fitted with the necessary check valves to provide back-syphonage protection in accordance with the Water Regulations.

The supply of hot and cold mains water directly to a bidet is permitted provided that it is of the over-rim flushing type and that a type 'A' air gap is incorporated.

#### Hot and Cold Water System

If the length of the hot water draw off pipework is excessive and the delivery time will be more than 60 seconds before hot water is available at the tap, you may wish to consider using trace heating to the hot water pipework such as the Raychem HWAT system. Please consult Gledhill Technical Department for further details.

**Note:** A conventional pumped secondary circulation system is **NOT** suitable for use with this appliance.

It is important that the cold water pipework is adequately separated/protected from any heating/hot water pipework to ensure that the water remains cold and of drinking water quality.

# 1.0 DESIGN

## 1.3 SYSTEM DETAILS

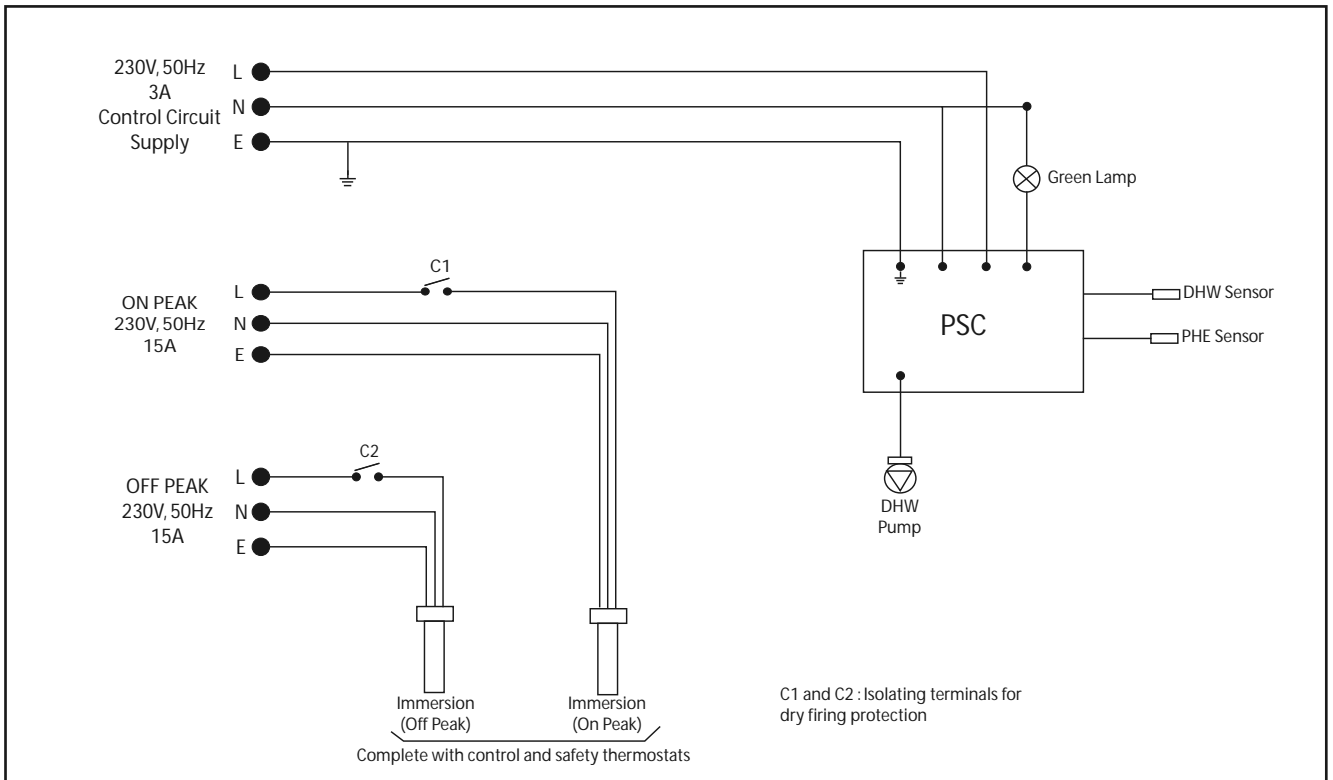

**PulsaCoil 2000 Schematic Wiring Diagram**

### Electrical Installation

The Schematic arrangement of the wiring within the PulsaCoil 2000 is shown above.

The whole of the electrical installation shall be designed and installed by a competent person fully in accordance with the latest edition of the Requirements for Electrical installations BS 7671.

The PulsaCoil 2000 appliance is provided with two side entry 3kW immersion heaters and has been designed to generally operate with an off peak supply.

The lower immersion heater heats the whole of the contents and is normally connected to the off peak supply.

# 1.0 DESIGN

## 1.3 SYSTEM DETAILS

### Electrical Installation

The upper immersion heater is positioned at a level on the PulsaCoil 2000 to provide sufficient hot water for at least one bath - see Technical Data Table on page 5. This is connected to the unrestricted on peak supply and is normally switched manually by the householder to provide a day time boost when required. Alternatively a time clock could be wired into this supply to provide an automatic boost on a daily basis if preferred.

The size of the appliance and the need to use the on peak boost facility is reduced if a better off peak tariff can be agreed with the electrical supply company - see Model Selection Guide on page 5.

A 3 amp supply is also required from the unrestricted on peak supply for the control circuit.

Although the PulsaCoil 2000 appliance is primarily designed to operate with an off peak supply it will also operate quite successfully if it is only supplied with an on peak supply. However, this will substantially increase the running costs of the appliance and should only be considered if an off peak supply is not available.

Two typical methods of providing electrical supplies are shown below for information. However, the PulsaCoil 2000 appliance is suitable for use with any method of supply - if unsure please consult Gledhill Technical Department for further assistance.

If separate circuits are provided the two switches must be clearly labelled for the householders use.

#### Note:

**In addition to the supplies to the immersion heaters, PulsaCoil 2000 requires a 3 amp supply for the control circuit. This 3 amp supply must be provided via a fused 3 amp double pole isolator providing 3mm of separation to both poles.**

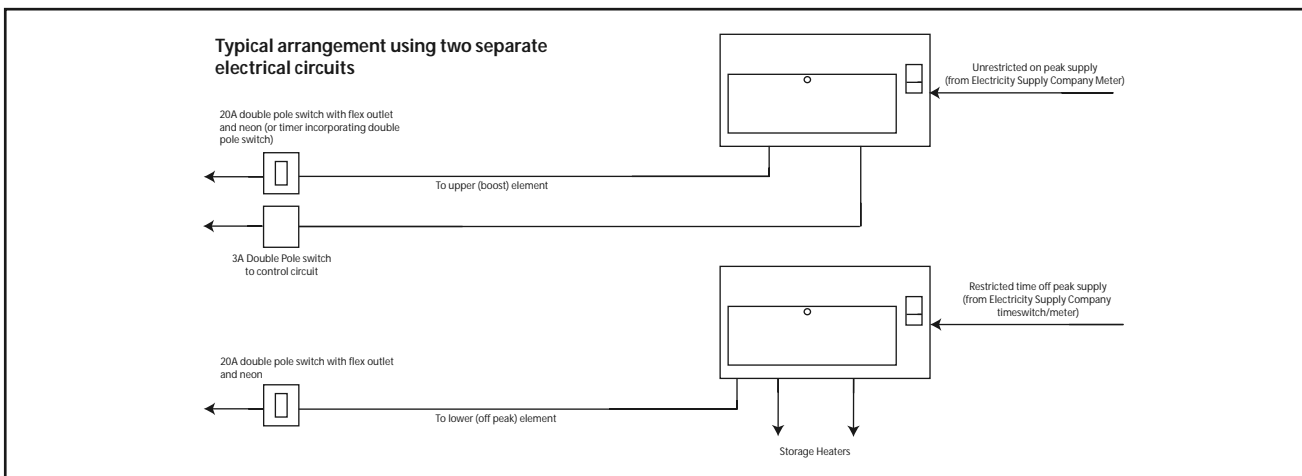
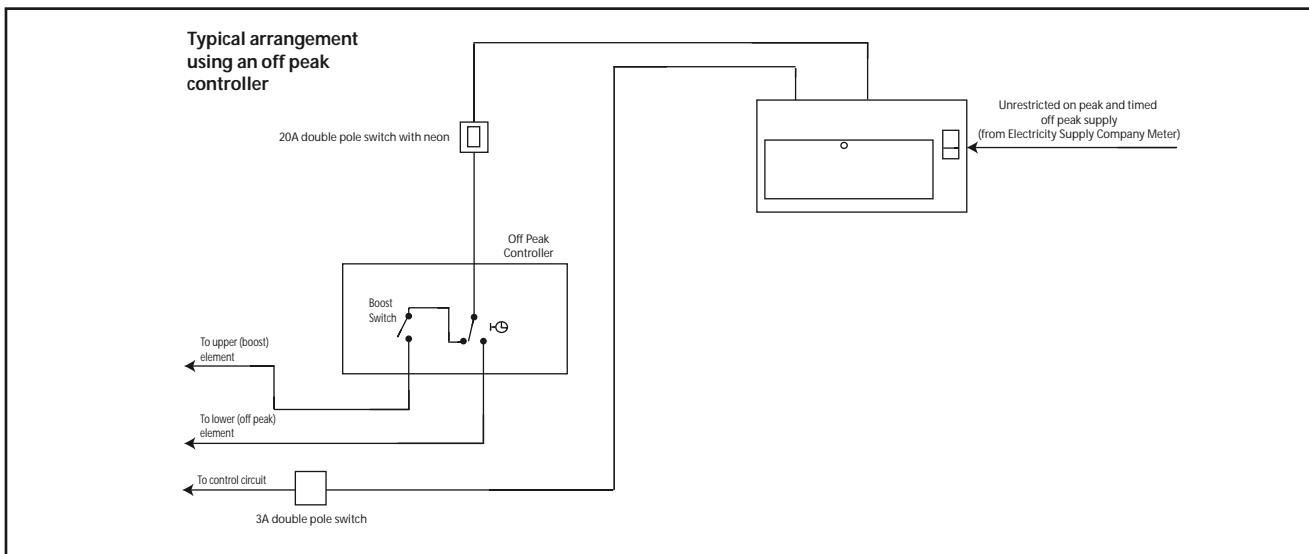

## 2.1 SITE REQUIREMENTS

The appliance is designed to be installed in an airing/cylinder cupboard and the relevant minimum dimensions are provided in section 1.2 Technical Data.

Because of the ease of installation we recommend that the cupboard construction is completed and painted before installation of the appliance. The cupboard door can be fitted after installation.

If the unit needs to be stored prior to installation it should be stored upright in a dry environment and on a level base/floor.

Installation and maintenance access is needed to the front of the appliance and above the F & E cistern. See Section 1.2 Technical Data for further details.

The minimum dimensions contained in section 1.2 Technical Data allow for the passage/connection of pipes to the appliance from any direction as long as the appliance is installed on the installation base provided. If the installation base is not used extra space may be needed to allow connection to the pipework and the whole of the base area should be continuously supported on a material which will not easily deteriorate if exposed to moisture.

The floor of the cupboard needs to be level and even and capable of supporting the weight of the appliance when full. Details of the weight when full is provided in section 1.2 Technical Data.

The appliance is designed to operate as quietly as practicable. However, some noise (from pumps etc) is inevitable when hot water is being used. This will be most noticeable if the cupboards are located adjacent to bedrooms, on bulkheads, or at the mid span of a suspended floor.

Cupboard temperatures will normally be higher than in a conventional system and the design of the cupboard and door will need to take this into account. No ventilation is normally required to the cupboard.

The separate feed and expansion cistern will need to be located on top of the appliance or at high level in the cupboard housing the PulsaCoil 2000. The dimensions and clearances are provided in section 1.2 Technical Data. The location will need to provide a suitable route for the cold feed and expansion pipe as well as the open safety vent pipe. The location will also need to provide a suitable route and discharge position for the warning/overflow pipe and the ballvalve supply from the mains cold water system (if provided).

**Note: The standard appliance is supplied with a cistern without a ballvalve/overflow for filling manually.**

An electrical supply must be available which is correctly earthed, polarized and in accordance with the latest edition of the IEE requirements for electrical Installations BS 7671.

The electrical mains supply needs to be 230V/50Hz.

The sizes/types of electrical supplies must be as detailed in 1.3 System Details, Electrical Installation and the connections must be made using a double-pole linked isolator with a contact separation of 3mm in both poles which are located within 1m of the appliance. The supplies must only serve the appliance.

The hot and cold water 'first fix' pipework should be terminated 50mm above the finished floor level in accordance with the dimensions provided in 1.2 Technical Data.

## 2.2 INSTALLATION

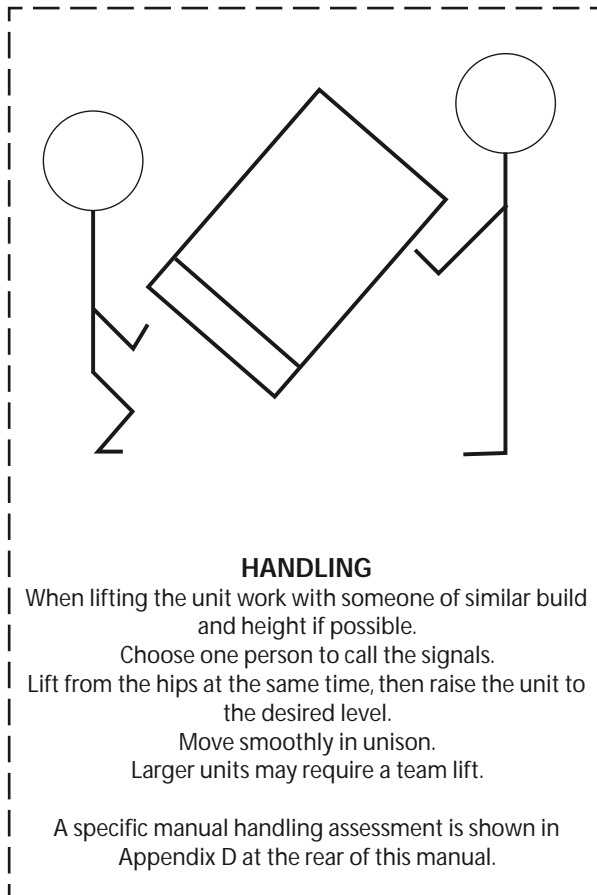

Before installation the site requirements should be checked and confirmed as acceptable.

The plastic cover and protective wrapping should be removed from the appliance and the installation base (provided) placed in position.

The appliance can then be lifted into position in the cupboard on top of the base and the front panel removed by unscrewing the 2 screws and lifting the door up and out, ready for connection of the pipework and electrical supplies.

The feed and expansion cistern support shall be installed ensuring that the base is fully supported, the working head of the appliance is not exceeded and the recommended access is provided for maintenance - see section 1.2 Technical Data for details.

### Preparation/placing the appliance in position.

The 'first fix' pipework positions should be checked using the template provided with each appliance. If these have been followed installation is very simple and much quicker than any other system.

The appliance is supplied shrink wrapped on a timber installation base. Carrying handles are also provided in the back of the casing.

The feed and expansion cistern complete with ballvalve, cold feed/expansion and overflow/warning pipe fittings are provided in a separate box.

If flexible connections have been ordered these will also be inside the feed and expansion cistern.

The appliance should be handled carefully to avoid damage and the recommended method is shown above.

**Note:** Although the above guidance is provided any manual handling/lifting operations will need to comply with the requirements of the Manual Handling Operations Regulations issued by the H.S.E.

The appliance can be moved using a sack truck on the rear face although care should be taken and the route should be even.

In apartment buildings containing a number of storeys we would recommend that the appliances are moved vertically in a mechanical lift.

If it is proposed to use a crane expert advice should be obtained regarding the need for slings, lifting beams etc.

# 2.0 INSTALLATION

## 2.2 INSTALLATION

### Pipework connections

The position of the pipework connections is shown opposite. The connection sizes and dimensions are listed in Section 1.2 Technical Data.

All the connections are also labelled on the appliance. It is essential that the pipework is connected to the correct connection.

The connections can be hard piped but we recommend the use of flexible connections (available as an optional extra).

If using push fit connectors with the flexible hose kits it is important to check that they are compatible. Written approval has already been obtained for:-

Hepworth - Hep<sub>2</sub>O BiTite  
John Guest - Speedfit  
Yorkshire - Tectite

However, as similar assurances cannot be obtained for Polypipe fittings we cannot recommend their use.

Connections A, B and D are plain ended copper pipe.

Connection C is a compression fitting.

Connection E is RC $\frac{1}{2}$  ( $\frac{1}{2}$  in BSPT internal)

- A - Safety open vent
- B - Cold feed/expansion
- C - Incoming mains cold water
- D - Domestic hot water
- E - Drain tap connection

**Note:** The safety open vent and cold feed/expansion should be connected to the F & E cistern using the pipework assembly provided.

All factory made joints should be checked after installation in case they have been loosened during transit.

The fittings for the feed and expansion cistern should be installed following the instructions provided by the manufacturer in a position to suit the particular location and the cistern fitted on its supports/base.

The cold feed/expansion and safety open vent should be installed between the appliance and the feed and expansion cistern.

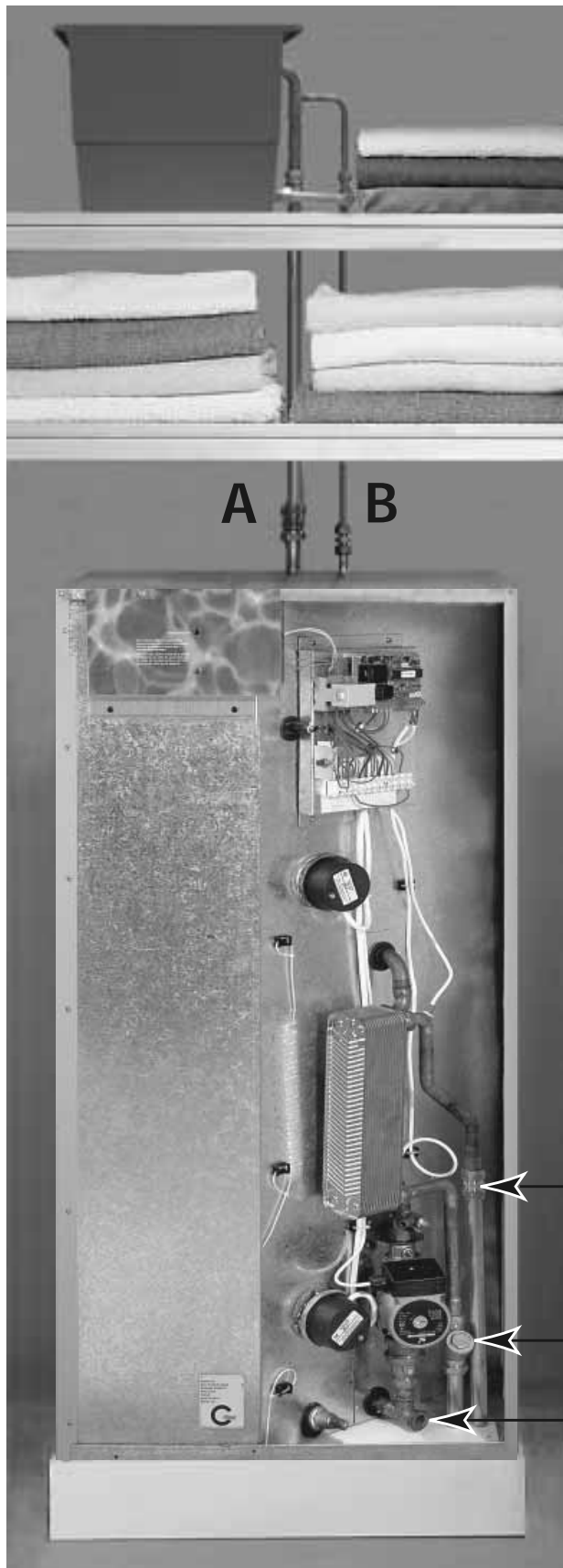

## 2.0 INSTALLATION

### 2.2 INSTALLATION

It is normally envisaged that the feed and expansion cistern will be located in the same cupboard as the PulsaCoil 2000 appliance itself to maintain a dry roof space.

The cold feed/open vent pipework assembly (as supplied) should be used if it is intended to install the F & E cistern directly on top of the appliance.

However, if it is necessary to locate the cistern in the roof space (or on a higher floor) the cold feed/open vent pipework assembly (as supplied) should be used to connect to the F & E cistern and pipework site run by the installer to connect this to the appliance.

Obviously, any pipework in the roof space and the feed and expansion cistern will need to be adequately insulated to protect against frost damage.

**Combined feed and open vent pipe arrangements must not be used.**

No valves should be fitted in the safety open vent which must be a minimum of 22mm copper pipe or equivalent.

The mains cold water supply to the ball valve shall be provided with a suitable servicing valve.

The overflow/warning pipe (if provided) shall have a continuous fall, be fitted to discharge clear of the building and be sited so that any overflow can be easily observed. It shall also be installed in a size and material suitable for use with heating feed and expansion cisterns in accordance with BS 5449 (e.g 22mm copper) and should not have any other connections to it.

**Note: If a warning/overflow pipe is NOT provided the F & E cistern should be filled from a temporary hose connection supplied from any cold water tap or from a permanent cold branch provided adjacent to the F & E cistern. The temporary hose must be fitted with a double check valve and removed once the appliance is filled.**

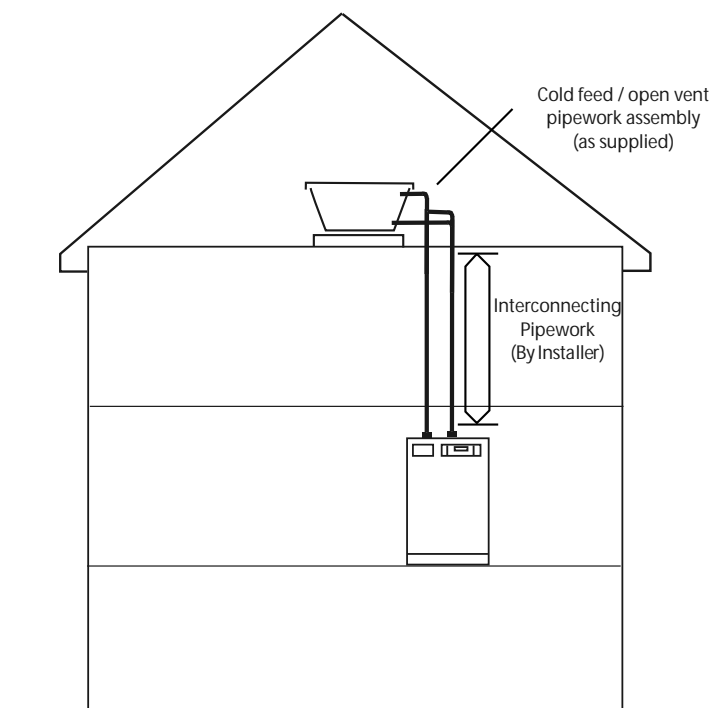



# 2.0 INSTALLATION

## 2.2 INSTALLATION

### WIRING DIAGRAM - STANDARD PULSACOIL 2000 APPLIANCE

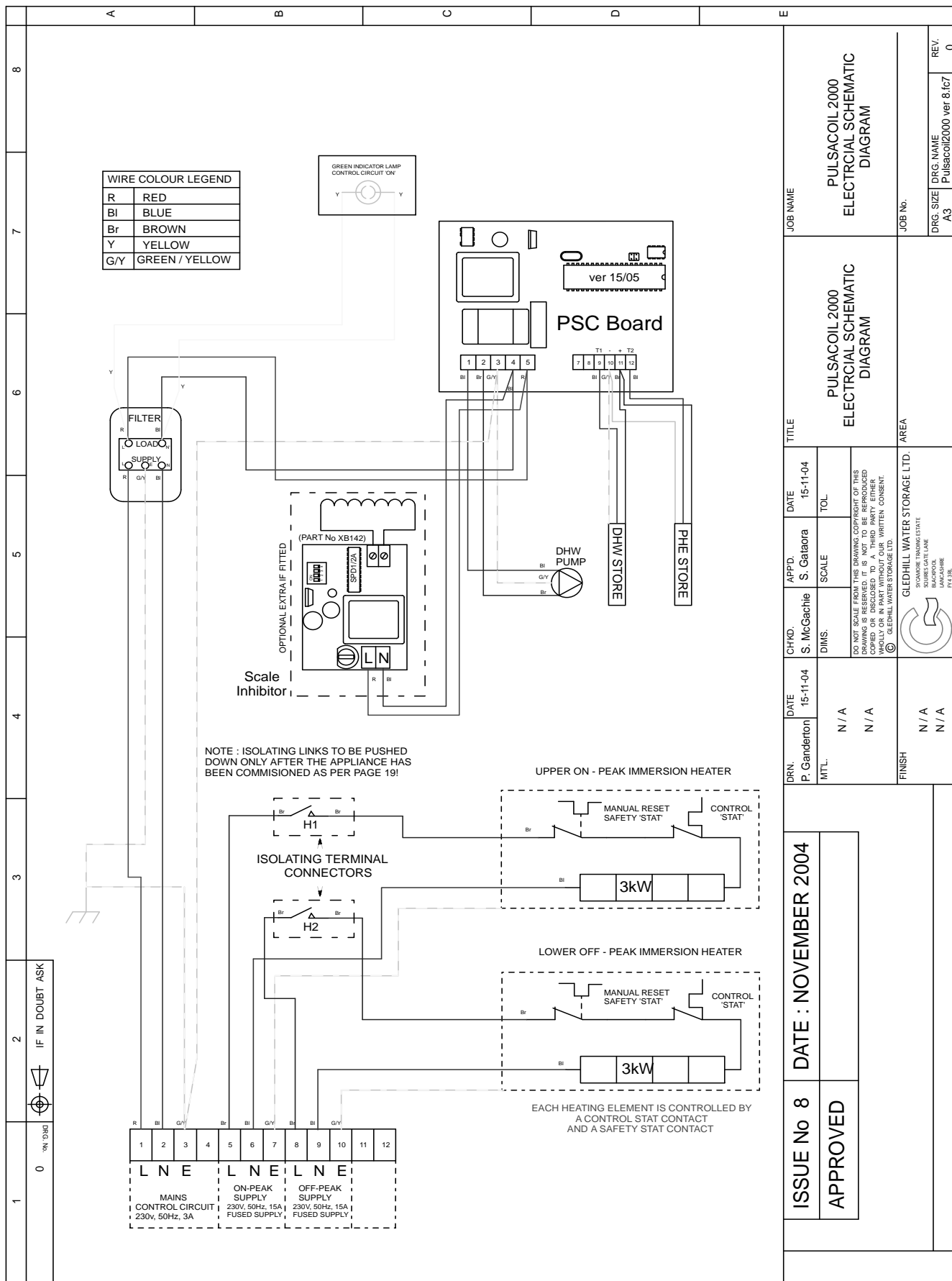

# 2.0 INSTALLATION

## 2.2 INSTALLATION

### Electrical Connection - Standard Appliance

The PulsaCoil 2000 is pre-wired to a 12 way terminal strip from the A.C.B. and plumbers are well able to complete the electrical installation as long as they are competent to carry out the work strictly in accordance with the IEE Requirements for Electrical Installations BS 7671. The arrangement of the wiring is shown on the previous page.

All the terminals are suitably labelled.

**Note:** Do not attempt the electrical work unless you are competent to carry it out to the above standards.

Before commencing check that the power source is in accordance with section 2.1 Site Requirements and ensure that it is isolated.

Run the external wiring from the adjacent isolator through the service slot provided in the base of the appliance.

Make the connections as shown opposite on the terminal strip provided.

Clamp the cables in the grips provided below the terminal strip and ensure all cables are routed to avoid hot surfaces.

**Note:** The appliance pipework should be bonded to earth to comply with the IEE Requirements for Electrical Installations BS 7671.

The appliance is provided with a 4.0mm earth cable from a strap on the case to the earth stud on the wiring panel.

Before switching on the electrical supply check all the factory made terminal connections to ensure they have not become loose during transit.

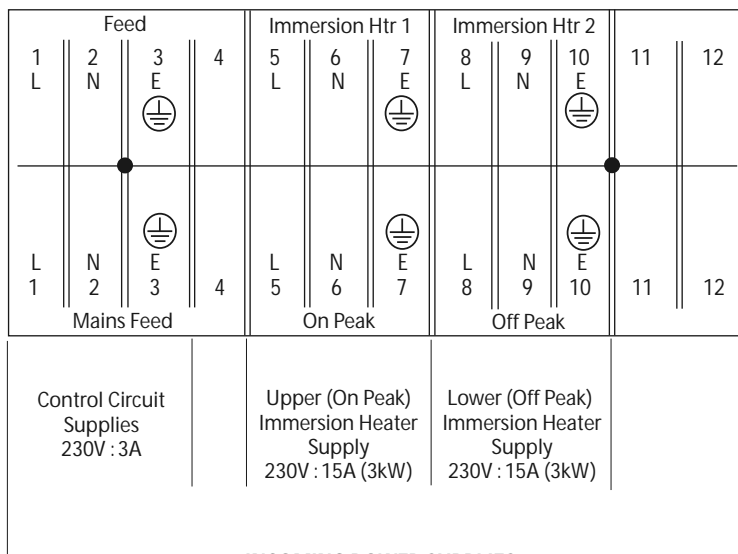

**INCOMING POWER SUPPLIES**

**NOTE:** The three 230V, 50Hz supplies should be as shown in the schematic diagram on page 12.

## 2.3 COMMISSIONING

Open the incoming stop valve and fill the domestic mains cold and hot water systems including the PulsaCoil 2000 appliance.

Check the water level in the feed and expansion cistern and if a ballvalve is fitted adjust if necessary.

Check the whole of the domestic hot and cold distribution systems for leaks.

## 2.3 COMMISSIONING

Fully flush and if necessary chlorinate the hot and cold water system in accordance with the recommendations in the Water Regulations and BS 6700.

**Once the system is finally filled turn down the servicing valve for the ballvalve in the F & E cistern to the point where the warning/overflow pipe will cope with the discharge arising from a ballvalve failure.**

**If an overflow is not provided ensure the temporary filling hose is isolated and removed from its connection to the cold water supply.**

It is essential that all systems function properly for optimum performance.

To achieve this the flow rate from each tap should be checked and a suitable number of taps run simultaneously to check the impact of this on the flow rate at individual taps.

**We recommend that flow restrictors are provided for each tap/terminal fitting to ensure that the available flow is shared evenly - See Appendix A for further details.**

### Commissioning the PulsaCoil Control System

Once the PulsaCoil 2000 is filled with water the electrical supply to the 3amp control circuit can be switched on and the switches on the two isolating terminal connectors can be pushed home.

**WARNING** - Pushing home these switches will complete the electrical circuit to the immersion heaters. **DO NOT PUSH HOME THESE SWITCHES AND SWITCH ON THE ELECTRICITY SUPPLY TO THE IMMERSION HEATERS UNTIL YOU HAVE CHECKED THAT THERE IS WATER IN THE F & E CISTERN**. Failure to do this will result in dry firing and premature failure of the immersion heaters, which will invalidate the warranty.

The green indicating lamp on the front of the appliance will light to show the control circuit supply is live.

The red indicating light is not connected on this version of the appliance.

When the green indicating lamp is lit switch on the on-peak (top) immersion heater and allow the appliance to reach temperature. Check that the rod thermostat mounted in the on peak immersion heater has switched off at the correct temperature of approx 72°C.

When this has been proven isolate the incoming power supplies and remove the incoming on and off peak supplies from the immersion heater supply terminals. Temporarily reconnect the on peak supplies to the off peak terminals (numbers 8, 9) and 10) and allow the appliance to reach temperature.

Check the rod thermostat has switched off the off peak immersion heater at the correct temperature of approx 72°C.

If the control thermostats do not switch off the immersion heaters at the correct temperature the integral overheat thermostat will operate the manual reset button. In this case check and adjust or replace the relevant rod control and overheat thermostat. Reduce the store temperature by running some hot water and repeat the test relevant to the immersion heater/control thermostat concerned.

Once it has been proved that the control thermostats are working correctly isolate the incoming power supplies and re-connect the immersion heater supplies in accordance with the details in 2.2 Installation.

Run a tap and using a digital thermometer check that the temperature of the hot water is about 55°C. This temperature is factory set and is independent of the store temperature and hot water flow rates.

**This product is covered by the 'Benchmark' scheme and a separate commissioning/service log book is included with this product. This must be completed during commissioning and left with the product to meet the Warranty conditions offered by Gledhill.**

### Important Do's and Don'ts

1. **DO** check the incoming mains water pressure. The preferred range of mains pressure is 2 -3 bar.
2. **DO** check the flow rate of the incoming cold water main is adequate to meet the maximum hot and cold water simultaneous demands.
3. **DO** check that all connections are in accordance with the labelling on the thermal store.
4. **DO NOT** push home the 2 switches on the isolating terminal connectors and switch on the electricity supply until you have checked that the appliance is full of water i.e. there is water in the F & E cistern.
5. **DO** check the water level is correctly set in the F & E cistern when cold and that there is no overflow when the appliance is up to temperature.
6. **DO** check that the rod thermostats switch the immersion heaters on/off at the correct set points i.e. approx 72°C.
7. **DO** insulate any exposed hot water pipework in the PulsaCoil cupboard.
8. If the ballvalve in the F & E cistern is permanently connected to the mains cold water supply **DO** plumb the overflow/warning pipe in a 20mm internal diameter pipe and ensure it discharges in a conspicuous external position. Use a material which is suitable for use with heating F & E cisterns in accordance with BS 5449 (such as copper).
9. **DO** ensure the green light is 'on'.
10. Once the appliance is filled and commissioned **DO** leave the electricity switched on to the appliance to ensure the automatic pump run facility can operate to prevent the pump sticking.
11. **DO** ensure that the functioning and control of the system is explained to the occupant.
12. **DON'T** place any clothing or other combustible materials against or on top of this appliance.

**These instructions should be placed along with the component manufacturers instructions in the pocket provided on the rear of the front panel. The front panel should then be refitted.**

## 3.0 SERVICING

### 3.1 ANNUAL SERVICING

No annual servicing of the PulsaCoil 2000 is necessary.

However, if required, the operation of the controls and a hot water performance test can be carried out to prove the appliance is working satisfactorily and within its specification.

### 3.2 CHANGING COMPONENTS

Free of charge replacements for any faulty components are available from Gledhill during the in-warranty period on return of the faulty part (normally 12 months).

After this, spares can be obtained direct from Gledhill using the 'Speed Spares' service, or through any of the larger plumbers merchants/specialist heating spares suppliers.

Help and advice is also available from the Technical Helpline on 08449 310000.

However, all components are readily accessible and can be changed quickly and easily by the installer using common plumbing practice.

If it is necessary to replace the pump fitted to the appliance the pump head (motor pack) only should be removed as recommended by Grundfos. Assuming it is within warranty this will be accepted by a merchant as being covered by the Grundfos national service exchange agreement, as long as it is a complete pump i.e. alleged faulty motor pack and new base is left with the merchant. It is important when a pump has been replaced to ensure that any air is adequately vented and the pump is set on speed 3.

# 3.0 SERVICING

## 3.3 SHORT PARTS LIST

Key No.	Description	Manufacturer	Stock Code No.	Gas Council Part No.
1	Feed and expansion cistern	Polytank	XB343	-
2	Ball float	Masfield/Epson	FT429	370 506
3	Ballvalve	Beta	FT207	370 505
4	Single check valve	Detail Plastic Co	GT048	E37 479
4	Brass housing	Midland Brass Co	GT049	-
5	15/50 pump with 1½" connections	Grundfos	XB001	384 288
6	22mm ball type pump valve	Vemco	XB121	E26 010
7	Plate heat exchanger	Swep	GT017	E05 664
8	Pump Speed Control board (P.S.C)	Elok	GT152	E26 023
9	Combined overheat thermostat		XB081	-
10	PHE return sensor	Elok	GT149	E26 024
11	D.H.W. temperature sensor	Elok	GT153	E26 024
12	20mm high break fuse 1 amp		-	-
13	'Y' Type strainer		XB314	-
14	Flow regulator		GT086	-
15	Immersion Heater		XB080	-
16	Electronic Noise Filter	Schaffner	XB307	-

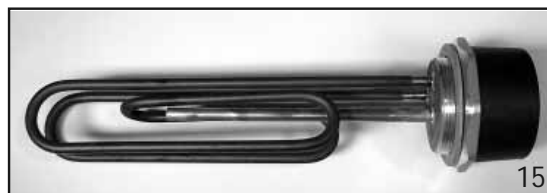
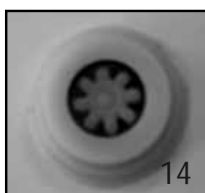
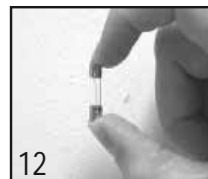
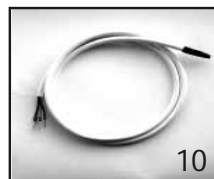
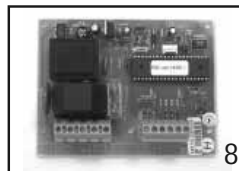

## 3.4 FAULT FINDING

Despite everyone's best efforts some problems can occur and lead to complaints from the householder.

The following checks should be carried out by the installer before calling the manufacturer.

### 1. Noise when hot water tap is opened/closed

If the plate heat exchanger pump is noisy when the hot water tap is opened, then check the level of water in the F & E cistern and vent the pump if necessary.  
Water hammer - loose pipework and/or tap washers.

### 2. Causes of 'Unsatisfactory Hot Water Service'

FAULT CONDITION	POSSIBLE CAUSES
DHW temperature remains cold exiting the taps.	<ul style="list-style-type: none"> <li>- Thermal store is cold/DHW pump is stuck</li> <li>- Temperature sensor or pump speed control PCB is faulty</li> <li>- Too little or too much flow from the pipe</li> <li>- The water level is low in the F&amp;E cistern.</li> <li>- Overheat stat tripped</li> </ul>
DHW temperature fluctuates wildly when flow is steady.	DHW pump keeps sticking when voltage is reduced and not starting until voltage is too high.
DHW temperature exceeds and remains well above 60°C when the flow rate is low.	<ul style="list-style-type: none"> <li>- DHW pump speed control PCB and/or temperature sensor is/are faulty.</li> <li>- Immersion heater thermostat temperature setting too high should be 72°C.</li> </ul>
Store not heating	<ul style="list-style-type: none"> <li>- The two switches on the isolating terminal connectors are not pushed home - i.e. unit is not commissioned.</li> <li>- No power supplies to control circuit and heaters</li> <li>- Overheat stat has tripped</li> </ul>

### 3. Overflow from Feed and Expansion Cistern

**Check** that the controlled level of water in the cistern is at the correct level.  
Adjust if required or check the ballvalve is shutting off the water supply.

# 3.0 SERVICING

## 3.4 FAULT FINDING

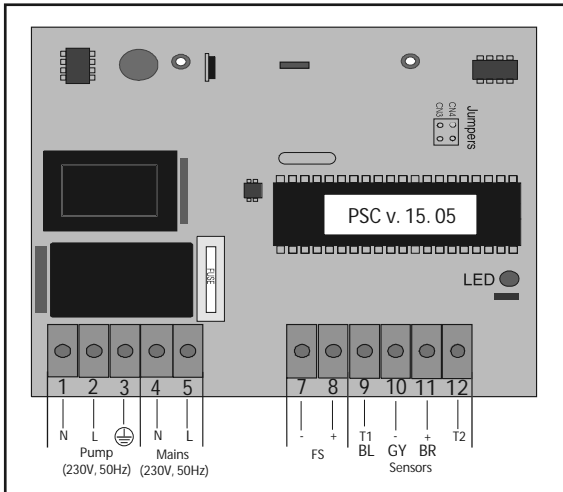

A number of the DHW faults indicated in the above chart will be indicated by the pump speed control PCB.

The layout of the pump speed control board is shown opposite. In faulty conditions if the hot water outlet temperature exceeds 60°, the pump speed will be reduced to minimum and if the outlet temperature exceeds 65°C, the pump will be switched off until the outlet temperature reduces to 50°C.

If hot water has not been used for a period of 30 hours the pump speed control board will run the pump for approximately 3 seconds to help prevent it sticking.

The red LED on the pump speed control board will also flash differently to indicate a number of fault conditions - see diagram opposite. If necessary change the faulty sensor (fault 2,3, or 4) board (fault 5) or fuse/check electrics (fault 6) to resolve the problem.

If the problem cannot be resolved by the installer the manufacturer should be contacted.

**When requiring a visit from the manufacturer the installer must have the completed 'Benchmark' commissioning/service record sheet to hand to enable help to be provided.**

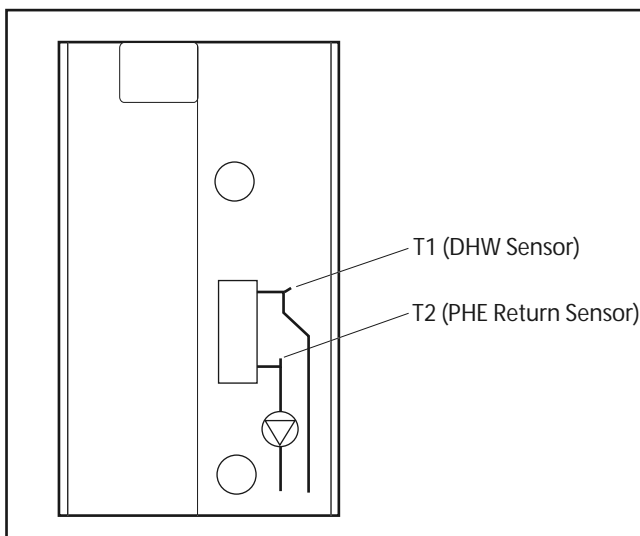
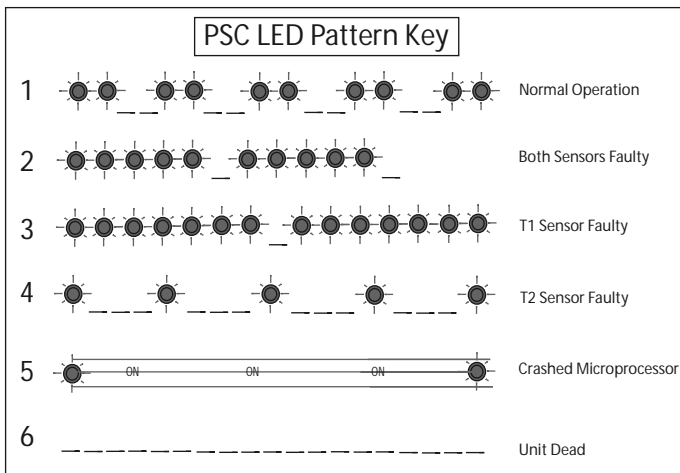

## WATER SAVINGS

WATER RELATED COSTS CAN BE REDUCED BY GOOD PLUMBING PRACTICE.

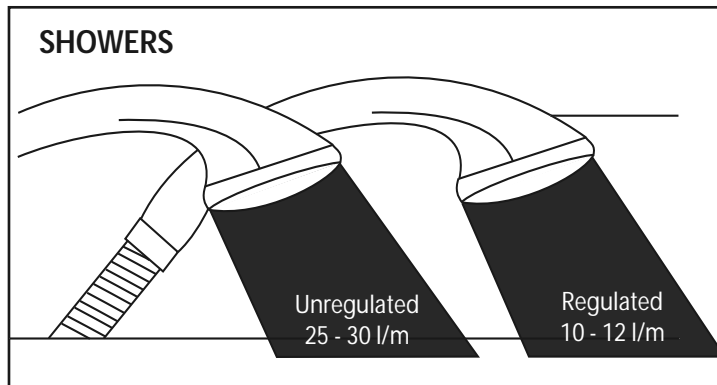
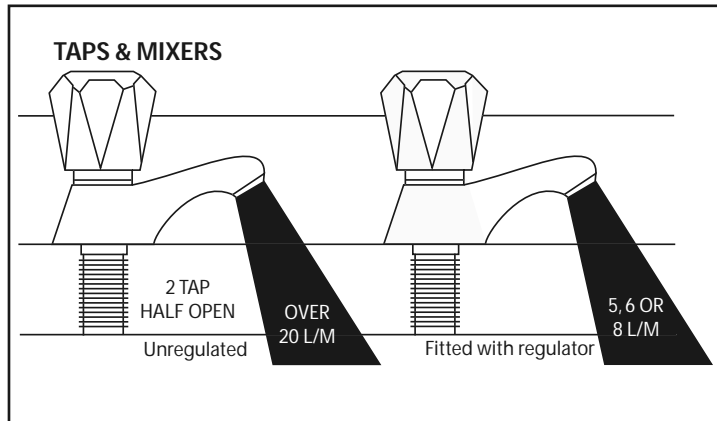

Vast quantities of water are needlessly run off to waste due to Taps, Mixers and Showers discharging flow rates far in excess of the rates required for them to perform their duties.

The contrasting flow rates shown on this leaflet clearly illustrate the savings that can be made whilst still providing a good performance.

British made Aquaflow Regulators provide constant flow rates by automatically compensating for supply pressure changes between 1 bar & 10 bars.

To facilitate installation into the wide range of plumbing equipment which is encountered in the U.K, Four Fixing Options are available:-

## OPTIONS FOR SHOWERS

1. MXF "DW" Range - For fitting behind Fixed Shower Heads or onto Flexible Hoses for Handshowers (preferably onto the inlet end when lightweight hoses are used).
2. Compression Fitting Range. "In Line" regulators as in Option 4 for Taps & Mixers.

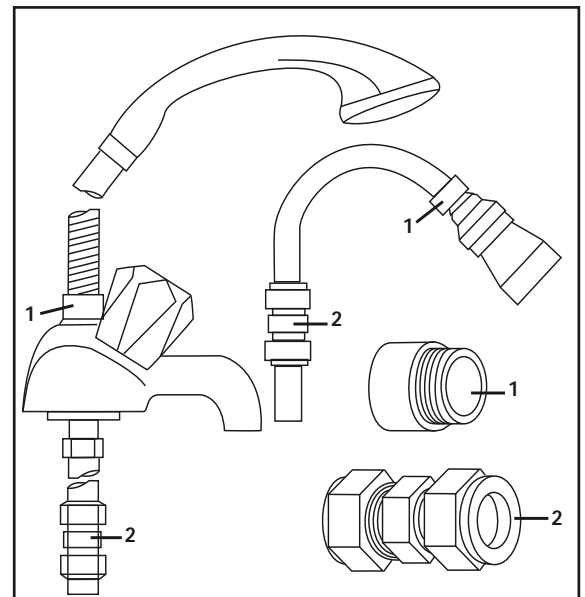

## 4 FIXING OPTIONS FOR TAPS & MIXERS

1. MK Range - Combined Regulators & Aerator for screwing onto Taps & Mixers with internal or external threads on their noses. Anti Vandal models also available.
2. MR05-T Range - Internal Regulators. Push-fit into Tap or Mixer seats. Produced in three sizes - 12.5mm (BS1010), 12mm & 10mm, Flangeless models also available for Taps with Low Lift washers.
3. MXF Standard Range - Screw on tail models for Taps & Mixers. Fix onto the tails before fitting the tap connectors. Available in 3/8", 1/2", 3/4" and 1" BSP.
4. Compression Fitting Range - "In Line" regulators housed in 15mm & 22mm CXC Couplers & Isolating Valves. UK WFS listed by the Water Research Centre. Isolation valves available for slotted screwdriver operation or with coloured plastic handles. Now available also in plastic bodied push-fit couplers & valves.

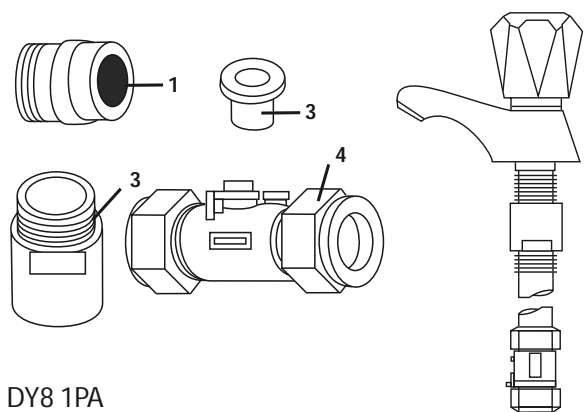

Information by courtesy of

**AQUAFLOW REGULATORS LTD**

Haywood House, 40 New Road, Stourbridge, West Midlands DY8 1PA  
TELEPHONE (01384) 442611 FAX: (01384) 442612



# APPENDIX B

## MANIFOLDS

Manifold type: 1 - Stock Code MIP 050 (one bathroom, one en suite shower room, one cloakroom, one kitchen)			
Flow regulator (litres/minutes)	Terminal fitting	Hot water manifold outlets Quantity	Cold water manifold outlets Quantity
18	Bath tap	1	1
9	Hand basin	3	3
12	Kitchen sink	1	1
9	Toilet cistern	None	3
9	Shower	1	1
12	Washing machine	1	1
9	Dishwasher	None	1
	<b>Total</b>	<b>7</b>	<b>11</b>

Two sets of manifolds are available as an optional extra. Each set comprises a separate hot and cold water manifold. Both are provided with a 22mm inlet connection located centrally. All outlet connections are 15mm compression. The centre to centre dimension of each branch is 55mm.

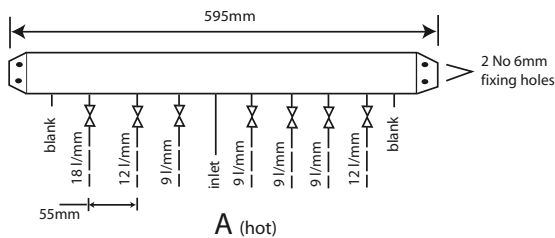

A (hot)

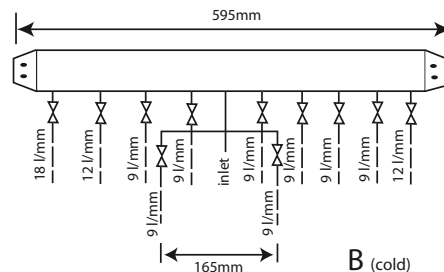

B (cold)

Manifold type: 2- Stock Code MIP 060 (two bathrooms, one en suite shower room, one cloakroom, one kitchen, one utility room)			
Flow regulator (litres/minutes)	Terminal fitting	Hot water manifold outlets Quantity	Cold water manifold outlets Quantity
18	Bath tap	2	2
9	Hand basin	4	4
12	Kitchen sink	2	2
9	Toilet cistern	None	4
9	Shower	1	1
12	Washing machine	1	1
9	Dishwasher	None	1
	<b>Total</b>	<b>10</b>	<b>15</b>

The arrangement of each manifold is supplied as shown. This provides the best balance of flows but the flow regulators/duty of each branch can be changed if required as long as a reasonable balance is maintained. If it is necessary to change or clean the flow regulator this can be done without needing to drain the system by closing the valve and removing the screwed cover below the white plastic cover.

The manifolds are designed to be used with plastic pipework and are supplied complete with isolation valves and flow regulators on each branch. They would normally be installed in the same cupboard as the thermal storage appliance (as shown on page 36) but can be installed in another cupboard close to the appliance if required.

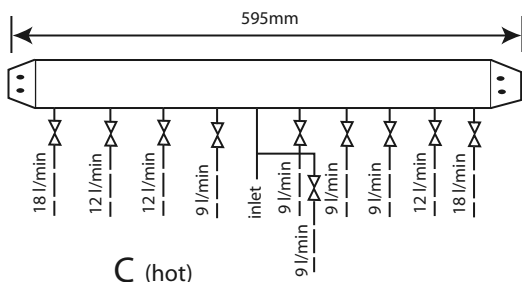

C (hot)

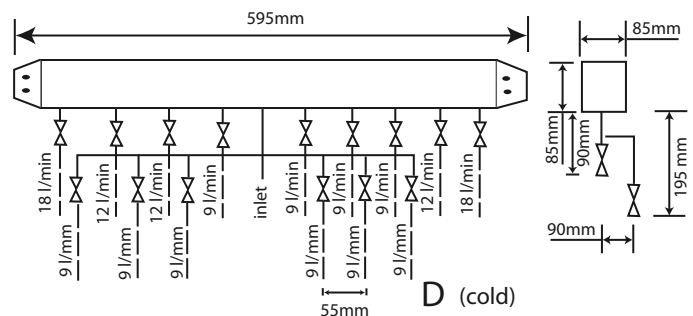

D (cold)

# APPENDIX B

*An optional location where cupboard space is tight*



*The preferred solution where space will allow*



The pressure loss through a flow regulator at the designated flow rate is about 1.8 bar. Therefore for the flow regulator to control the flow rate at pre-set level, the inlet pressure must be greater than 1.8 bar. If the inlet pressure is lower, the flow rate will be correspondingly less than the pre-set values.

The maximum equivalent pipe lengths from the manifold to the terminal fittings can be estimated from the above information and the resistance characteristics of the pipes. The examples presented below are for 15mm copper pipe in table 1 and for plastic pipework in table 2.

Table 1: Maximum equivalent pipe length in 15mm copper

Inlet pressure (bar)	Maximum equivalent length of pipe (m)		
	@ 9 l/m	@ 12 l/m	@ 18 l/m
2.0	25	10	5
2.5	75	30	15
3.0	150	60	30

Table 2: Maximum equivalent pipe length in plastic pipe

Inlet pressure (bar)	Maximum equivalent length of pipe (m)		
	@ 9 l/m	@ 12 l/m	@ 18 l/m
2.0	1.5	15mm : 10	15mm : 4.5 22mm : 40
2.5	3.0	15mm : 20	15mm : 9.0 22mm : 80.0
3.0	4.5	15mm : 30	15mm : 13.5 22mm : 120

# APPENDIX B

The size of the distribution pipes supplying the manifold should be calculated using the method set out in BS 6700. A typical diagrammatic arrangement of a system using Manifold Type 1 is shown below. This is only meant to show the principles involved and the actual connection of fittings to the manifold will need to suit the arrangements shown on page 35.

**Note 1** - If it is proposed to fit chemical water treatment such as a water softener this should be fitted in this location and the cold water branch in the sink should be branched off the cold water main prior to the treatment device instead of the cold water manifold.

Any other isolating/control valves and backflow protection devices should be provided as necessary to comply with the Water Regulations.

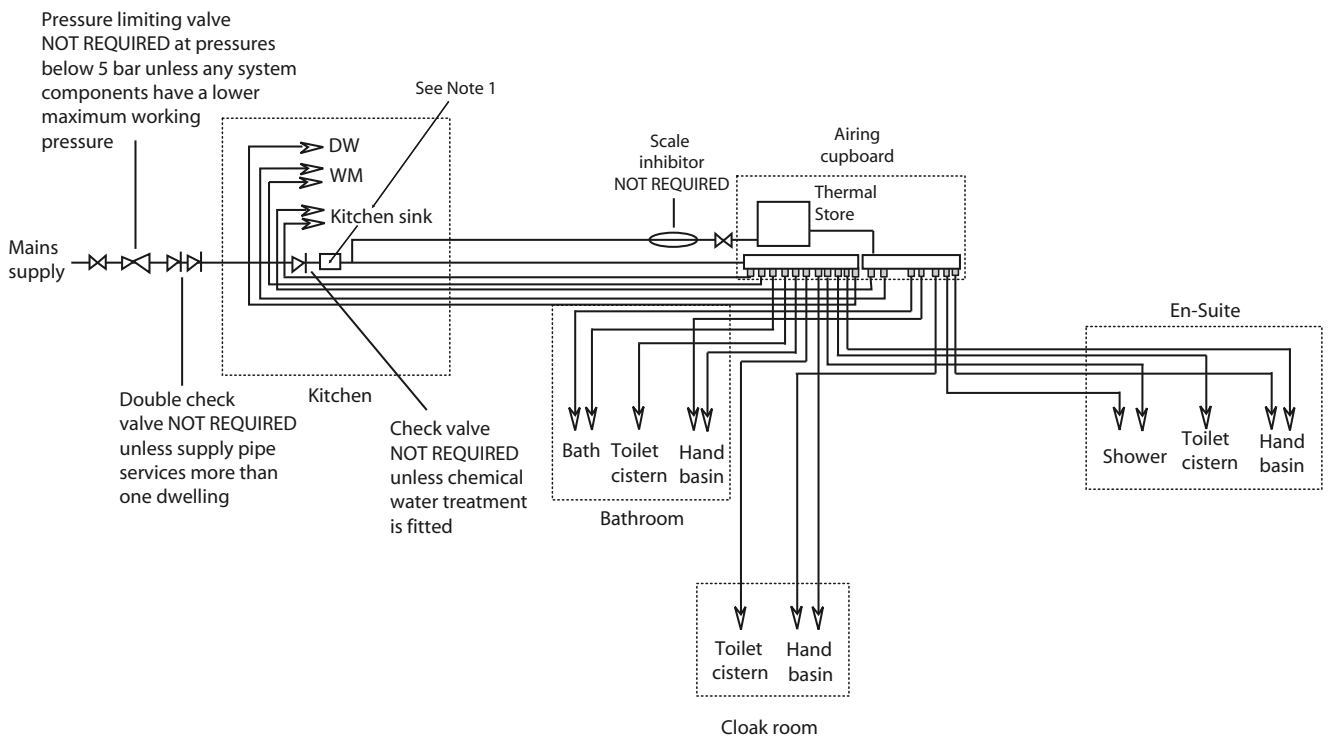



## 2 Inhibitor (Corrosion & scale protection of primary heating circuit)

On filling the heating system and before the boiler is fired up, it is important to ensure the system water is treated with a suitable corrosion inhibitor, in accordance with the boiler manufacturer's instructions.

Since the concentration of inhibitor present in a system can become diluted, for a number of different reasons, the system should be checked annually and re-treated as required, or after every full or partial drain-down. A water treatment manufacturer's test kit may be used to check the correct concentration of inhibitor in the system.

Where recommended by a boiler manufacturer, a 'physical corrosion protection device' may be fitted in the primary pipework in accordance with the boiler manufacturer's instructions.

The Benchmark log book should be completed indicating the date and details of any of the above products added and a permanent label should be fixed to the system in a prominent location.



## 3 Scale protection (Domestic hot water service)

Where a combi boiler and/or a hot water storage vessel is installed in areas where the mains water can exceed 200ppm Total Hardness (as defined by BS 7593: 1993 Table 2) a scale reduction device should be installed, in accordance with the boiler manufacturer's instructions. The levels of water hardness may be measured using a water hardness test kit.

### BUILDING REGULATIONS

Completion of the BENCHMARK log book requires that the 'competent person' undertaking the installation and commissioning provide information relating to Cleaning, Inhibitor and Scale Protection. This will demonstrate that the work complies with the requirements of the appropriate Building Regulations.

This Guidance Note is produced on behalf of its members by the Central Heating Information Council. For a full list of members visit [www.centralheating.co.uk](http://www.centralheating.co.uk) and for further advice on water treatment contact the following members:

Culligan Sentinel Fernox Salamander Engineering Scalemaster

Heating & Hotwater Information Council, 36 Holly Walk, Leamington Spa,  
Warwickshire CV32 4LY Tel: 0845 600 2200 Fax: 01926 423284  
[www.centralheating.co.uk](http://www.centralheating.co.uk)

## MANUAL HANDLING OF APPLIANCE PRODUCTS

### Description

Manual handling means any transporting or supporting of a load (including lifting, putting down, pushing, pulling, carrying or moving) by hand or bodily force.

### Scope

This assessment will cover the largest Appliances, namely ElectroMate, GulfStream, BoilerMate, SyntoMate, PulseCoil, Accolade and Stainless Lite manufactured by Gladhill.

The maximum weight of the largest product in each range is 98kg and the size is 595 x 595 x 2020 mm high.

### Main Hazards

Vision may not be clear due to the size of the products. Adopting an incorrect method of lifting may cause injury, attempting to lift these products will require help from others. (Team lifts)

### Control Measures

#### Manual lifting procedure

The lift, key factors in safe lifting are:

- a. Balance
- b. Position of back
- c. Positioning of the arms and body
- d. The hold
- e. Taking the lead for team lifts

a. **Balance** - Since balance depends essentially upon the position of the feet, they should be apart about hip breadth with one foot advanced giving full balance sideways and forward without tension. In taking up this position, lifting is done by bending at the knees instead of the hips and the muscles that are brought into use are those of the thigh and not the back.

b. **Position of back** - Straight - not necessary vertical. The spine must be kept rigid, this coupled with a bent knee position, allows the centre line of gravity of the body to be over the weight so reducing strain.

c. **Positioning of arms and body** - The further arms are away from the side, the greater the strain on the shoulders, chest and back. Keep elbows close to the body arms should be straight.

d. **The hold** - Before lifting ensure you have a good hold. Two handles are provided on Appliance products at the top rear side, these allow one or two persons to have a purposely-designed hold at the top of the appliance to ensure easy lifting at the top of the product. Each appliance is supplied with a pallet, which has been attached to the unit via the packaging. The pallet will also allow for one or two persons to get a good hold.

e. **Taking the lead for team lifts** - As more than one person is required for these products ensure that one person is taking the lead. This may be you so ensure that each person that is helping is made aware of the weight and of the items listed within this assessment. Make sure you and any others helping know the route you intend to take that it is clear of any obstructions. Never jerk the load as this will add a little extra force and can cause severe strain to the arms, back and shoulders. If there are steps involved decide on where you will stop and take a rest period. Move smoothly and in unison taking care to look and listen to others helping with the lift. Where possible use a sack truck to move the product over long flat distances, only lift the products when necessary. If in doubt stop and get more help. The unit handles and packaging with the pallet have been designed to ensure that two-four people can assist when lifting up stairs or over longer distances.

#### Individual capability

Individual capability plays an important part in handling these products. Persons above average build and strength will find it easier and should be in good health. Persons below average build and strength may require more rest periods during the handling process.

Pregnant women should not carry out this operation.

Persons who are not in good health should seek medical advice prior to commencing any lifting or manual handling operation.

#### Residual risk

Following the guidelines given above will reduce any risk to injury.

All persons carrying out this operation must be fully trained and copies of the specific risk assessment made available for inspection and use in their training process.

Further guidance on Manual Handling can be obtained from the Health and Safety Executive. Manual Handling Operations Regulations 1992.

# Gledhill (Water Storage) Ltd

AMD, JUNE 2018

## CONDITIONS OF SALE & GUARANTEE TERMS

1. Gledhill (Water Storage) Ltd ("We" or "Gledhill") only the business operates the Conditions which appear below and no other. Unless we so agree in writing these Conditions shall apply in full to any supply of goods by us to the purchaser of any Conditions or terms sought to be imposed by any purchaser. These Conditions of Sale and Warranty Terms override those which are contained on the invoice forms and all Sales are made subject to these Conditions of Sale and Warranty Terms only.

### 2. PRICE

Once an order or call off has been accepted the price will be held for three months but if delivery is delayed beyond that period at the customer's request, then we reserve the right to amend the price when necessary. The company reserves its pricing flexibility to adjust for changes in our cost base. We reserve the right to alter prices at any time for various reasons in raw materials (particularly copper and steel). If there is to be a change we will give customers at least 30 days notice and anything delivered after that date will be at the revised price. An order may not be cancelled or varied after acceptance without the written consent of the company. Such cancellation or variation shall be subject to such reasonable charges as may be appropriate.

### 3. SPECIFICATION

The goods are supplied in accordance with the Specifications (if any) submitted to the Purchaser and any additions and alterations shall be the subject of an extra charge. Any goods not so specified shall be in accordance with our printed literature or the literature of any of our component suppliers (subject to any modifications made since publication). If we accept any change in construction or design of the goods, or in the specifications printed in our literature, the Purchaser shall accept the goods as changed in fulfillment of the order.

### 4. PAYMENT

The invoice price of goods shall be payable within 30 days of dispatch by us of our invoice for the goods or such longer time as may be stated by our quotation or invoice. If we receive payment in full or before the due date we will allow an appropriate settlement discount, except where we have quoted a special net price. If payment is not received in full or before the due date we shall be entitled in addition to the invoice price to:

- (i) payment of a sum equal to any increase in the copper price supplement applicable to the particular goods sold between the date of receipt of order and the date of receipt of payment in full; and
- (ii) interest on any part of the invoice price unpaid after the due date at the rate of 3% per annum over the base rate for the time being of the Bank of England.

### 5. TITLE

We give certificates of delivery date in good faith and time of delivery is not a condition of the contract and we shall not be liable for any loss or damage occasioned by delay in delivery.

### 6. DELIVERY

We deliver normally by our own vehicles within 25 miles of any of our manufacturing depots. Delivery to any place more than 25 miles from one of our manufacturing depots may be subject to our special delivery charges. We reserve the right to make delivery of goods consistent in our order by manufacturer's arrangement and at different times. Where a partial is agreed for delivery and such partial is not undertaken by our Agreement, the Purchaser shall take delivery of the first partial. If the Purchaser fails to take delivery, we shall be entitled at the Purchaser's risk and expense to store the goods at the Purchaser's premises or elsewhere and to demand payment as if they had been dispatched. Off loading at point of delivery shall be the responsibility of the purchaser by the Purchaser.

### 7. INSPECTION OR DAMAGE

Goods need be inspected before shipment of delivery note and any damage, steel age or discrepancy noted on the delivery note and the goods released on the same vehicle. The buyer must also give to immediate written notice of the change, shortage or discrepancy so that we may prompt investigation.

### 8. RETURN OF GOODS

Goods may not be returned to the Company except by prior written permission of an authorized officer of the Company and such return shall be subject to payment by the Purchaser of handling and re-stocking charges, transport and other costs incurred by the Company.

### 9. COMPANY LIABILITY AND GUARANTEE

9.1. Subject to the terms of these Conditions of Sale and in accordance with the Electrically Protected Guarantee in respect of specific products as set out in this clause.

9.2. Each Guarantee is hereby constituted upon the following:

9.2.1. Completion must be given to us immediately, before any claim is made, as responsibility cannot be accepted if repairs or services are attempted on site without our written approval.

9.2.2. The unit has been installed in accordance with manufacturer's and service instructions and all relevant codes of practice and regulations in force at the time of installation.

9.2.3. All relevant inlet controls and safety valves have been fitted correctly.

9.2.4. The unit has only been used for the storage of potable water supplied from the public mains.

9.2.5. Where appropriate the unit has been regularly maintained as detailed in the installation and service instructions.

9.2.6. Defects caused by corrosion or scale deposits are not covered by any Guarantee.

9.2.7. Where we agree to rectify any defect we reserve the right to undertake the work on our own premises.

9.3. Guarantees are provided in respect of specified goods supplied by Gledhill as follows:

(i) Domestic and Commercial Open Ventilated Cylinders and Tanks.

The copper storage vessel is guaranteed for ten years and if it proves to be defective either in materials or workmanship, we will either repair or supply replacement at our option with the cost of materials in the case of any obsolete parts to any address in Great Britain.

(ii) Five of all charge during the first year after delivery by us.

(iii) Thereafter at a charge of one-fifth of the then current list price and any copper price supplement and delivery charge during the second year after delivery by us and increasing by a further one-fifth on the second and subsequent anniversary of delivery by us.

(iv) Domestic Water Pail Products (Primary Storage)

The copper storage vessel is guaranteed for five years and if it or any integral pipework as part of the storage vessel assembly proves to be defective either in materials or workmanship, we reserve the right to either repair or supply replacements or the closest possible substitute in the case of any obsolete product and will collect and deliver to any address in England, Wales and Scotland (excluding all Scottish islands).

(v) Five of all charge during the first year after delivery by us.

(vi) Thereafter at a charge of one-fifth of the then current list price and any copper price supplement and delivery charge during the second year after delivery by us increasing by a further one-fifth on the second and subsequent anniversary of delivery by us.

(vii) Integrated Inlet and Storage Pail Products and Stand Alone Inlets

In the case of the Gledhill range of products and the Electrically Protected range of products, Gledhill guarantees the hot exchange (inlet) for material and construction faults for two years. THE RESPONSIBILITY FOR THE EXECUTION OF THIS GUARANTEE LIES WITH THE INSTALLER.

The guarantee is given as well and void if the appliance is used incorrectly, or in the event of power negligence or incorrectly implemented repairs OR FAILURE TO CARRY OUT THE RECOMMENDED INSPECTION/ MAINTENANCE. The guarantee also becomes null and void if changes are made to the appliance without our knowledge, or if the serial number on the appliance is removed or made illegible.

The annual service must be carried out by a competent installer in accordance with the advice given by Gledhill and using Gledhill approved parts.

(ii) Domestic/Stand Unvented Cylinders

Gledhill guarantees the components including controls, valves and electrical parts for two years from the date of purchase. IT SHOULD BE NOTED THAT THE FACTORY FITTED TEMPERATURE AND PRESSURE RELIEF VALVE MUST NOT BE REMOVED OR ADJUSTED IN ANY WAY OR THE GUARANTEE WILL NOT BE VALID. GLEDHILL WILL NOT BE RESPONSIBLE FOR ANY CONSEQUENTIAL LOSS OR DAMAGE HOWEVER IT IS CAUSED.

The guarantee for the standard steel vessel is for twenty five years if the original unit is returned to us AND PROVIDED THAT:

(i) It has been installed as per the Design, Installation & Servicing Instructions, relevant standards, regulations and codes of practice.

(ii) It has not been modified, other than by Gledhill.

(iii) It has not been subjected to wrong or improper use or ill treatment.

(iv) It has only been used for the storage of potable water.

(v) It has not been subjected to third damage.

(vi) The benchmark log book is completed after each annual service.

(vii) The unit has been serviced annually.

It should be noted that the guarantee does not cover:

- the effects of scale build up

- any other charges associated with replacing the unit or parts.

If the standard steel vessel proves to be defective either in materials or workmanship we reserve the right to either repair or supply replacements or the closest possible substitute in the case of any obsolete product and will collect and deliver to any address in England, Scotland and Wales (excluding all islands).

(i) Five of all charge during the first year after delivery by us.

(ii) Thereafter at a charge of one-fifth of the then current list price during the second year after delivery by us and increasing by a further one-fifth on the second and subsequent anniversary of delivery by us.

### ACTING IN THE EVENT OF FAILURE

If the standard steel cylinder develops a leak we will either a deposit against the supply of a new one. This will be refunded if the failure is within the terms of the warranty when it has been accepted by us.

(ii) Solar Panels and ancillary equipment

Gledhill provides a five year warranty for defects in the collector (except broken glass and collector accessories eg metal slippage). If the collector demonstrably fails to meet one of the requirements of the standard EN1287 part 3 we will replace it free of charge based on the date of invoice. We can not be responsible for damage caused by mechanical stress and/or changes caused by weather related influences. The warranty excludes minor surface damage that does not affect performance or malfunction due to improper assembly or installation.

### Please note

- Installation must have been carried out by a licensed specialist company (installing contractor or plumber) following the vendor's installation instructions in force.

- Gledhill or its representative has given the opportunity to check complete on site immediately after any defect occurred.

- Confirmation exists that the system was commissioned properly and that the system was checked and maintained was performed annually by a specialist company licensed for this purpose.

(i) Components of our products other than Storage Vessels and Inlet Pipework

We will either refund to the purchaser the same value of warranty as we are given by the manufacturer of the component or if the manufacturer does not give any warranty, replace free of charge any component which becomes defective within two years after the date of the delivery by us and is returned to us at the purchaser's expense but we shall not be liable for the cost of removal or shipping or return of the component or any other cost charges or damages incurred by the purchaser.

If the appliance manufacturer Gledhill incorporates a factory fitted scale inhibitor then during the period

of five years from the date of delivery. Shellill will replace, free of charge, any photo heat exchanger fitted in the appliance or original equipment in which a coil has become loose that materially reduces the effectiveness of the photo heat exchanger. This guarantee does not extend to any other component installed within the Shellill appliance or elsewhere in the Purchaser's domestic water system.

**9A.**

9A.1. In respect of goods supplied by us and in respect of any installation work carried out by us or our staff, our entire liability and the purchaser's sole remedy (subject to the Guarantees) shall be as follows:-

- (a) We accept liability for death or personal injury to the extent that it results from our negligence or that of our employees.
- (b) Subject to the other provisions of this clause 9 we accept liability for direct physical damage to tangible property to the extent that such damage is caused by our negligence or that of our employees, agents or subcontractors.
- (c) Our total liability in this purchase order and above any liability in respect of the Guarantees (whether in contract or in tort including negligence) in respect of any one cause of loss or damage claimed to result from any breach of our obligations (however, shall be limited to actual monetary damages which shall not exceed £20,000 provided that such monetary limit shall not apply to any liability in the part of our obligations referred to in paragraph (a) above.
- (d) Except as provided in paragraph (a) above but otherwise not withstanding any provision herein contained in no event shall we be liable for the following loss or damage, however caused and even if same results by us or from our negligence:-
  - (i) economic loss which shall include loss of profits, business income, goodwill or anticipated savings.
  - (ii) damages in respect of special interest or consequential loss or damage (other than death, personal injury and damage to tangible property)
  - (iii) any claim made against the purchaser by any other party (save as expressly provided in paragraph (b) above)
- (e) Except in respect of our liability referred to in paragraph (b) above no claim may be made or action brought (whether in contract or in tort including negligence) by the purchaser in respect of any goods supplied by us more than one year after the date set in section 6 for the relevant goods.
- (f) Without prejudice to any other term we shall not be liable for any water damage caused directly or indirectly as a result of any leak or other defect in the goods. We cannot control the condition of use of the goods or the time or manner or location in which they will be installed and the purchaser agrees to be fully responsible for testing and checking all works which include the goods at all relevant times (up to, including and after commissioning and following all necessary steps to identify any leaks and prevent any damage being caused thereby).
- (g) Nothing in these Conditions shall confer on the purchaser any rights or remedies to which the purchaser would not otherwise be legally entitled.

**9B. LOSS OF EARNINGS**

Notwithstanding any other provision contained herein the purchaser's liability agrees to fully indemnify us against any damages, losses, costs, claims or expenses incurred by us in respect of any claim brought against us by any third party (as:-

- (a) any loss, injury or damage wholly or partly caused by any goods supplied by us or their use.
- (b) any loss, injury or damage wholly or partly caused by the defective installation or substandard workmanship or materials used in the installation of any goods supplied by us.
- (c) any loss, injury or damage in any way connected with the performance of this contract.
- (d) any loss resulting from any failure by the purchaser to comply with its obligations under these terms as to install and/or check, vents correctly.

Provided that this paragraph will not require the purchaser to indemnify us against any liability for our own acts of negligence or those of our employees, agents or sub-contractors.

Provided in the case of goods supplied by us which are re-sold and installed by a third party by the purchaser we will be the sole responsibility of the purchaser to test the goods immediately after their installation to ensure that later alterations are correctly installed and in preventing water from leaks and are not likely to cause any loss, injury or damage to any person or property.

**11. WAIVER OF REMEDY AND EXCLUSION**

Should our warranty and sections be unacceptable we are prepared to negotiate for variation in their terms but only on the basis of an increase in the price to allow for any additional liability or risk which may result from the variation.

Purchasers are advised to insure against any risk or liability which they may incur and which is not covered by our warranty.

**12. RELEASED BY THE PURCHASER**

Goods supplied by us shall be at the Purchaser's risk immediately upon delivery in the Purchaser or into custody on the Purchaser's behalf or in the Purchaser's Dealer. The Purchaser shall accept adequate insurance of the goods against all risks in their full insurable value of the goods, such insurance to be effected within the time of delivery until property in the goods shall pass to the Purchaser as hereinafter provided.

- (a) property in the goods supplied hereunder shall pass to the Purchaser when full payment has been made by the Purchaser to us for:-
  - (i) the goods of the subject of this contract.
  - (ii) all other goods the subject in of any other contract between the Purchaser and us which, at the time of payment of the full price of the goods sold under this contract, have been delivered to the Purchaser but not paid for in full.
- (b) until property in the goods supplied hereunder passes to the Purchaser in accordance with paragraph (a) above,
  - (i) the Purchaser shall hold the goods in a delivery capacity for us and shall store the same separately from any other goods in the Purchaser's possession and in a manner which satisfies them in its interest as our goods.
  - (ii) the Purchaser shall immediately return the goods to us should our authorized representative so request. All the necessary incidents associated with a fiduciary relationship shall apply.
- (c) the Purchaser's right to possess the goods shall cease forthwith upon the happening of any of the following events, namely:-
  - (i) if the Purchaser fails to make payment in full for the goods within the time stipulated in clause 4 hereof.
  - (ii) if the Purchaser, not being a company, commits any act of bankruptcy, makes a proposal in its or her capacity for a compromise or does anything which would entitle a petition for a Bankruptcy Order to be presented.
  - (iii) if the Purchaser, being a company, does anything or fails to do anything which would entitle an administrator or an administrative receiver or a receiver to take possession of any assets or which would entitle any person to present a petition for winding up or to apply for an administration order.
- (d) the Purchaser hereby grants to us an irrevocable licence to enter at any time any vehicle or premises owned or occupied by the Purchaser or in the possession of the Purchaser for the purpose of repossessing and

repossessing any such goods the property in which has been assigned in the earlier paragraph (2) above. We shall not be responsible for and the Purchaser will indemnify us against liability in respect of damage caused to any vehicle or premises in such repossession and removal being damaged which it was not reasonably practicable to avoid.

(e) notwithstanding paragraph (5) hereof and subject to paragraph (7) hereof, the Purchaser shall be permitted to sell the goods to third parties in the normal course of business. In this regard the Purchaser shall act in the capacity of our commission agent and the proceeds of such sale:-

- (i) shall be held in trust for us in a manner which satisfies such proceeds to be identified as such, and;
  - (ii) shall not be mixed with other monies nor paid into an overdraw bank account.
- We, as principal, shall reimburse the Purchaser as commission agent a commission depending upon the surplus which the Purchaser can obtain over and above the sum, stipulated in this contract of supply which sells itself as:-

(f) in the event that the Purchaser shall sell any of the goods pursuant to clause (e) hereof, the Purchaser shall forthwith inform us in writing of such sale and of the identity and address of the third party to whom the goods have been sold.

(g) If, before property in the goods passes to the Purchaser under paragraph (2) above the goods are or become affixed to any land or building owned by the Purchaser it is hereby agreed and declared that such affixation shall not have the effect of passing property in the goods to the Purchaser. Furthermore if, before property in the goods shall pass to the Purchaser under paragraph (2) hereof, the goods are or become affixed to any land or building (whether or not owned by the Purchaser), the Purchaser shall:-

- (i) ensure that the goods are capable of being removed without material injury to such land or building.
- (ii) take all necessary steps to prevent title to the goods from passing to the landlord of such land or building.
- (iii) forthwith inform us in writing of such affixation and of the address of the land or building concerned.

The Purchaser warrants to repair and make good any damage caused by the affixation of the goods to or their removal from any land or building and to indemnify us against all loss, damage or liability we may incur or sustain as a result of affixation or removal.

- (i) in the event that, before property in the goods has passed to the Purchaser under paragraph (2) hereof, the goods or any of them are lost, stolen, damaged or destroyed:-
- (ii) the Purchaser shall forthwith inform us in writing of the fact and circumstances of such loss, theft, damage or destruction.
- (iii) the Purchaser shall engage to us in the event of any insurance claim in respect of the goods so lost, stolen, damaged or destroyed.

**13. NON-PAYMENT**

If the Purchaser shall fail to make full payment for the goods supplied hereunder within the time stipulated in clause 4 hereof or to us in default of payment for any other reason then, without prejudice to any of our other rights hereunder, we shall be entitled to stop all deliveries of goods and materials to the Purchaser, including deliveries or further deliveries of goods under this contract. In addition we shall be entitled to terminate all outstanding orders.

**14. VALUE ADDED TAX**

All prices quoted are exclusive of Value Added Tax which will be charged at the rate ruling at the date of dispatch of the goods.

**15. TRADE MARK ONLY**

We are only prepared to deal with those who are not consumers within the terms of the Unfair Contract Terms Act 1977, the Sale of Goods Act 1979 and the Supply of Goods and Services Act 1982. Accordingly any person who purchases from us should be deemed to have represented that he is not a consumer by so purchasing.

**16. JURISDICTION**

This agreement is subject to English law for products delivered in England and Scotland and for products delivered in Scotland and any dispute hereunder shall be settled in accordance therewith depending upon the location.

